

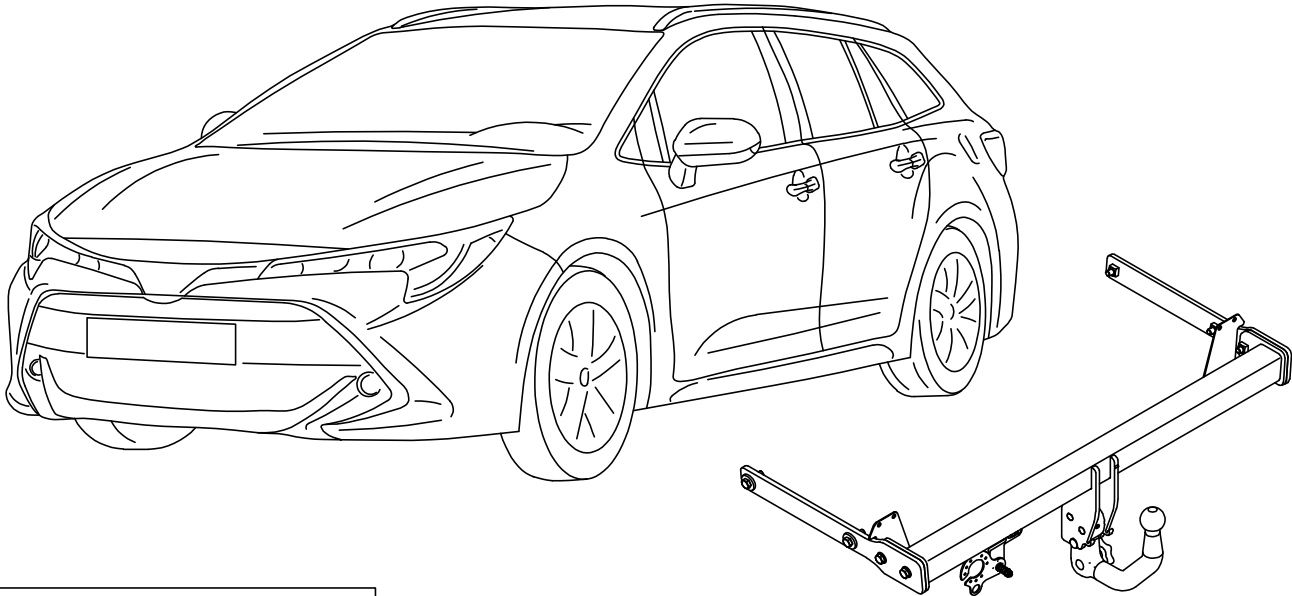

Die Anhängerkupplung.

Anhängerkupplungen
und Elektrosätze
direkt vom Hersteller



MVG: 3670 A

**Toyota Corolla Touring Sports (Hybrid)
Suzuki Swace**

D Einbauanleitung

GB Installation instruction

F Notice de montage

I Istruzioni di montaggio

E Instrucciones de montaje

CZ Návod k montáži

NL Inbouw instructie

S Monteringsanvisning

MVG-Metallverarbeitungsgesellschaft mbH

An der Wasserwiese 1
52249 Eschweiler
Deutschland

Tel.: +49 (0) 2403 7902-60
Fax: +49 (0) 2403 7902-99
E-Mail: info@mvg-ahk.de

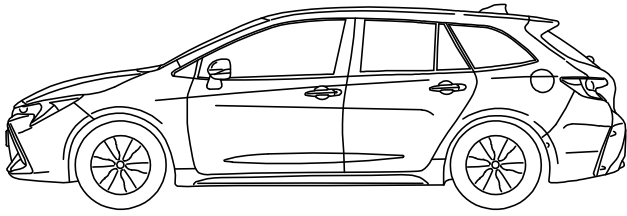

↓ ≤ 1955 kg

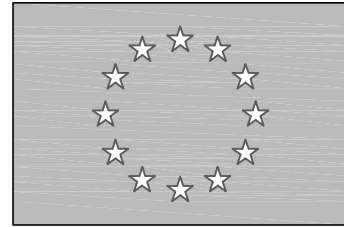

EG

e6 * 2007/46 * 0318
e6 * 2007/46 * 0485

$$D = 8,6 \text{ kN}$$

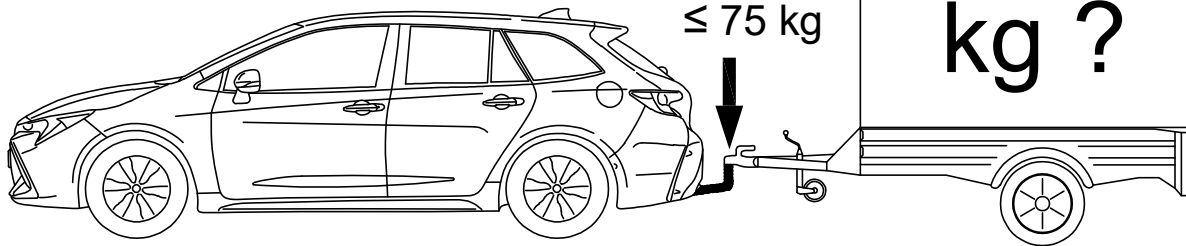

$$D = \frac{T \times R}{1000 \times (T + R)} \times g$$

$$g = 9,81 \text{ m/s}^2$$

$$T = \frac{R \times D \times 1000}{(g \times R) - (1000 \times D)}$$

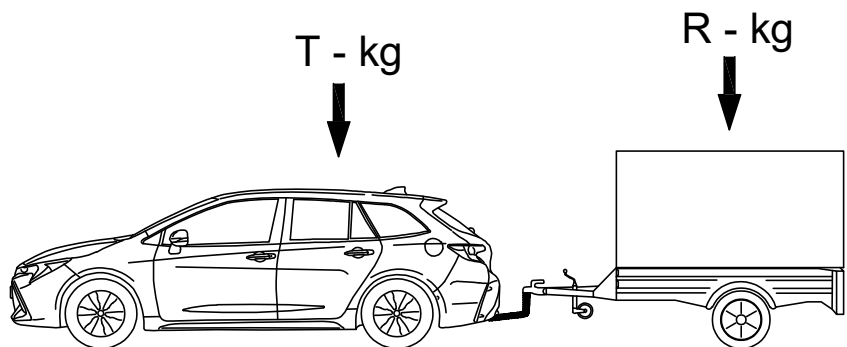

$$R = \frac{T \times D \times 1000}{(g \times T) - (1000 \times D)}$$

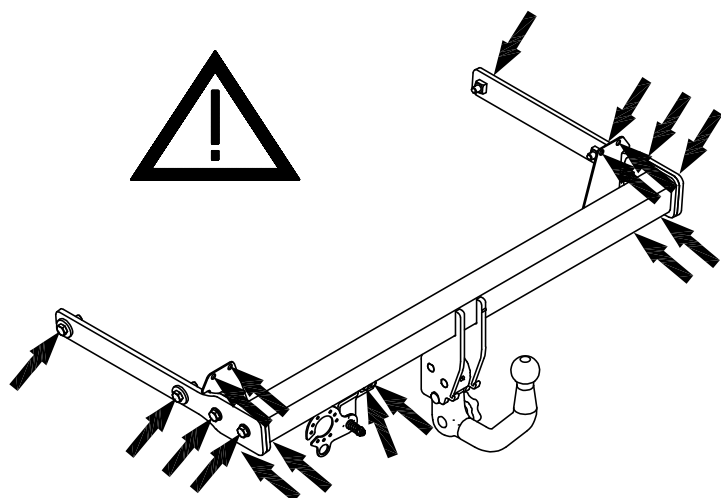
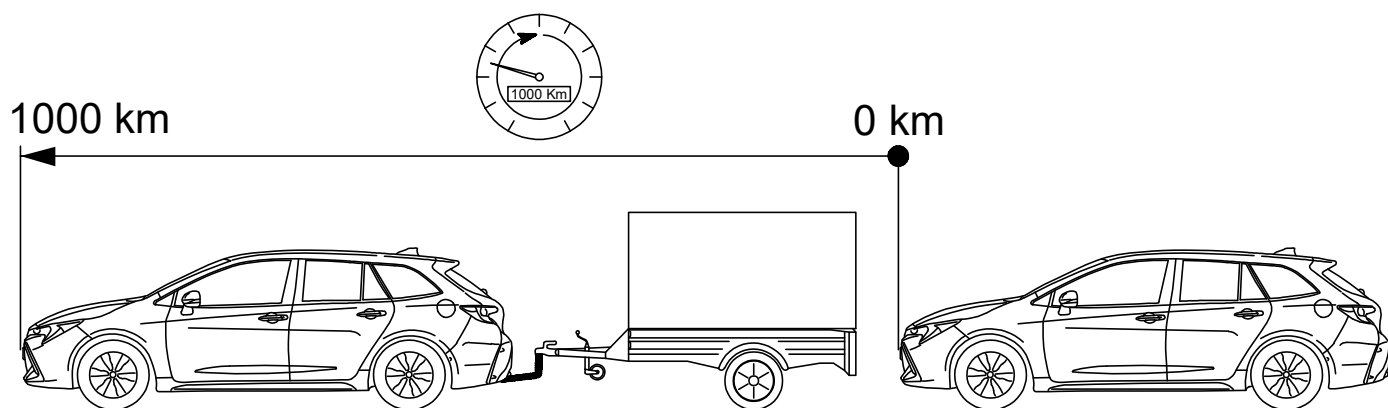
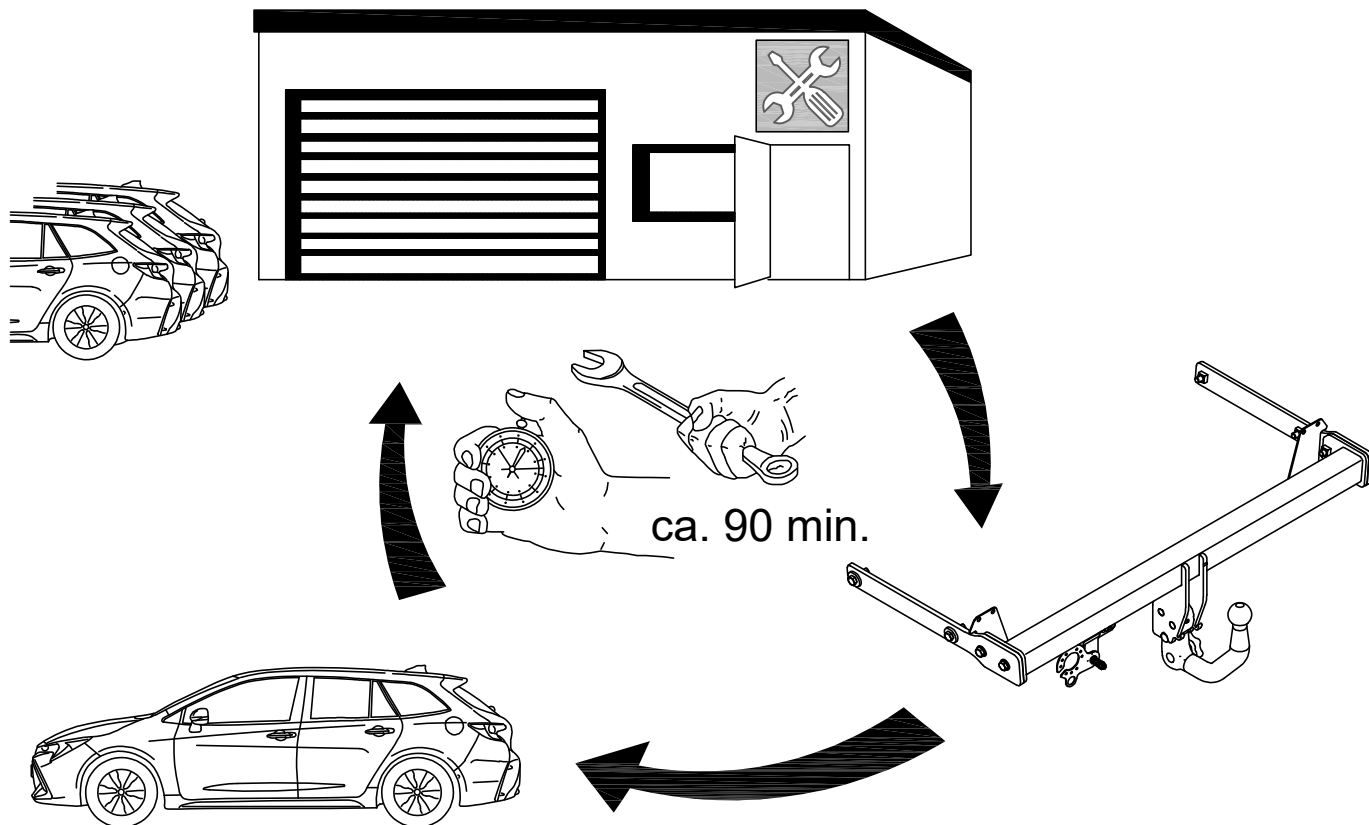

 <p>M6 M12</p>	<p>8 Nm 100 Nm</p>
---	------------------------

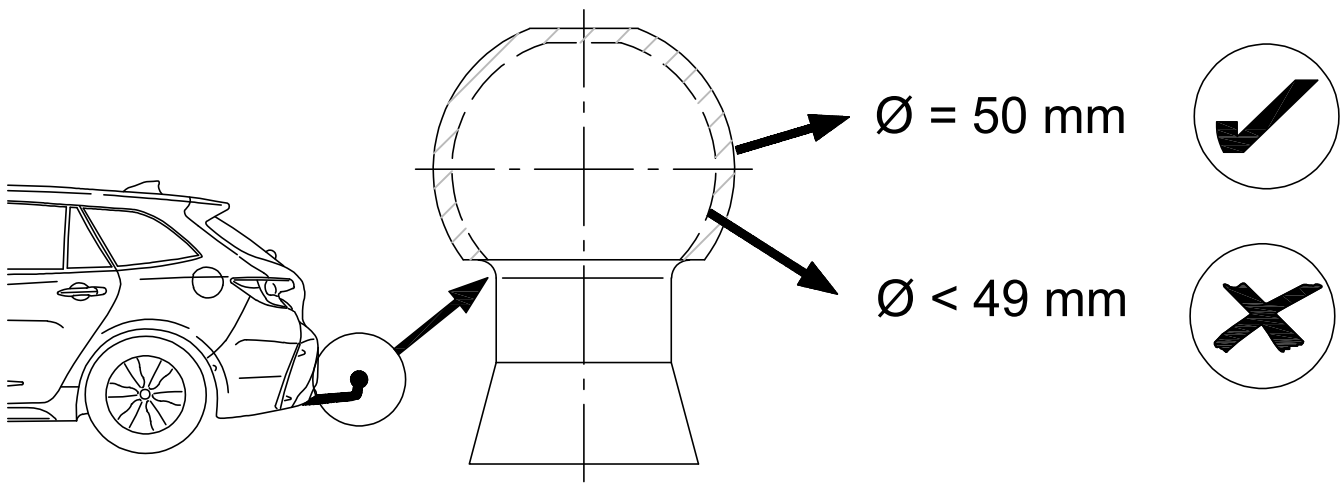

MVG[®] Approval Number
 MVG-Metalverarbeitungsgesellschaft mbH **E4** 55R-02 1197

Type: 3670 A D-Value: 8,6 kN
 Class: A50-X S-Value: 90 kg
 Made in Germany www.mvg-ahk.de

Zulässige Stützlast
 maximal 75 kg

MVG[®]
 MVG-Metalverarbeitungsgesellschaft mbH
 www.mvg-ahk.de

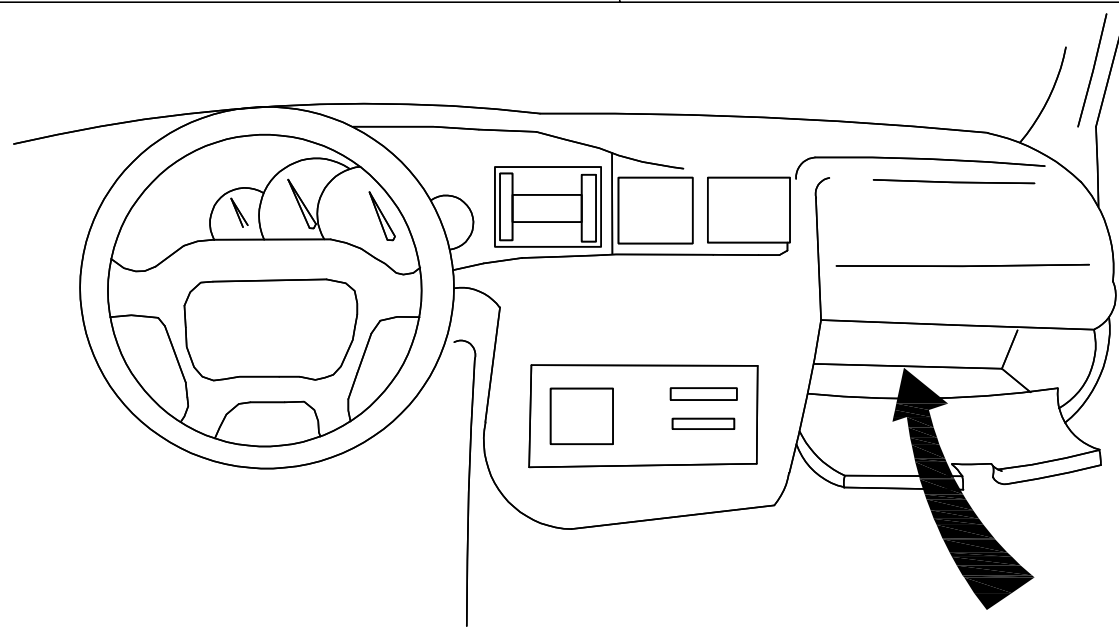

Technische Änderungen vorbehalten

MVG

MVG-3670 A
 Toyota Corolla Touring Sports (Hybrid)
 Suzuki S-Blaze

✓	✓	✓	✓
✓	✓	✓	✓
✓	✓	✓	✓
✓	✓	✓	✓

MVG-Metalverarbeitungsgesellschaft mbH
 Am der Dübener Heide 1 74639 Berlin-Neukölln
 10405 Berlin, Deutschland Tel. +49 (0) 30 245 14000
 Fax. +49 (0) 30 245 14001
 E-Mail: info@mvg-ahk.de

MVG

MVG-System: 2040

✓	✓	✓	✓
✓	✓	✓	✓
✓	✓	✓	✓
✓	✓	✓	✓

MVG-Metalverarbeitungsgesellschaft mbH
 Am der Dübener Heide 1 74639 Berlin-Neukölln
 10405 Berlin, Deutschland Tel. +49 (0) 30 245 14000
 Fax. +49 (0) 30 245 14001
 E-Mail: info@mvg-ahk.de

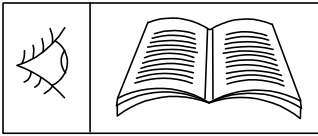

siehe Werkstatthandbuch

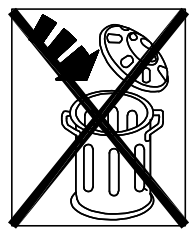

Nicht Entsorgen

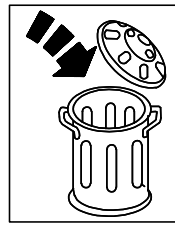

Entsorgen

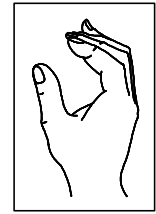

Von Hand



Achtung

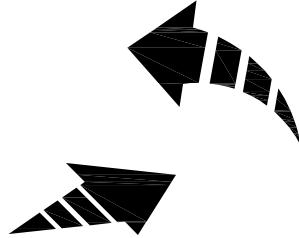

Bewegungspfeil



Positionspfeil

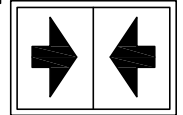
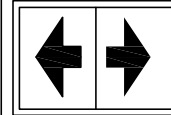

Stecker lösen/ verbinden



Achtung Hochvolt

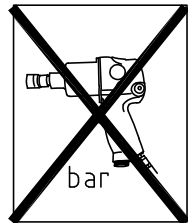

Ohne Druckluft

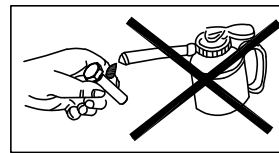

Nicht ölen

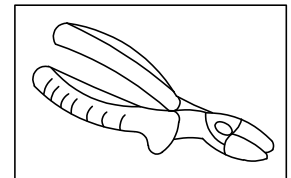

Seitenschneider verwenden

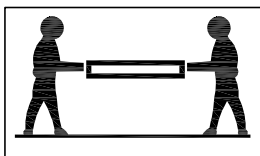

Nur zu zweit ausführen

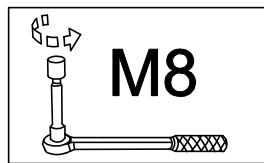

Festdrehen

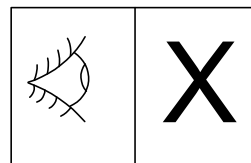

Siehe Abbildung

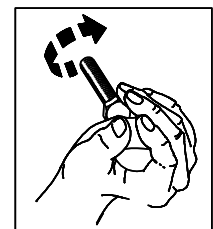

Von Hand festdrehen

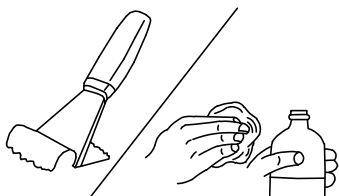

CLEANER
Unterbodenschutz entfernen
(Reinigen)



Gegen Korrosion schützen

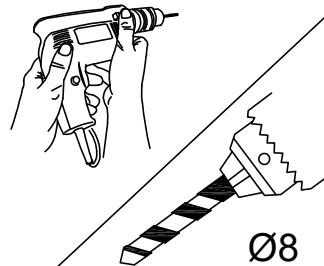

Bohrer verwenden



Kleben

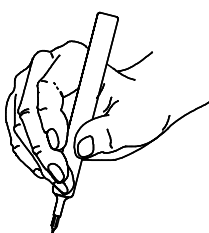

Anzeichnen

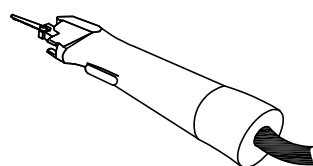



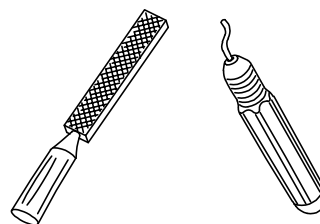



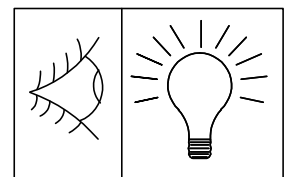



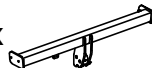

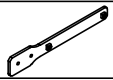





Schneiden









Feilen/ Entgraten

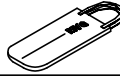

Licht kontrollieren

1	1x		3670 A		
2	1x		2040 A 100		
3	2x				
4	2x				
5	8x		M12x40 (10.9)	ISO 4017	
6	4x		Ø13/ 35x5	DIN 6340	
7	4x		Ø13/ 24x2,5	ISO 7089	
8	2x		M6x25 (8.8)	ISO 4017	
9	4x		Ø6,4/ 12x1,6	ISO 7089	
10	2x		M6 (8)	ISO 7042	
11	1x				
12	1x				
13	1x		M8x45 (8.8)	ISO 4017	
14	1x		Ø8,4/ 16x1,6	ISO 7089	
15	1x				
16	1x				
17	2x		Ø8,4/16x1,6	DIN 125 PA 6.6	
18	1x		M8 (8)	ISO 7042	

19	1x		3670 A		
20	1x		System 2040		
21	1x				0062
22	1x		75 kg		1016
23	1x				1012
24	2x				

D Lieferumfang der Anhängervorrichtung

GB Scope of delivery of towing hitch

F Pièces comprises dans la fourniture de l'attelage

I Dotazione del gancio di traino

E Volumen de suministro del enganche

CZ Objem dodání tažného zařízení

NL Leveringsomvang trekhaak

S Dragkrokens leveransspecifikation

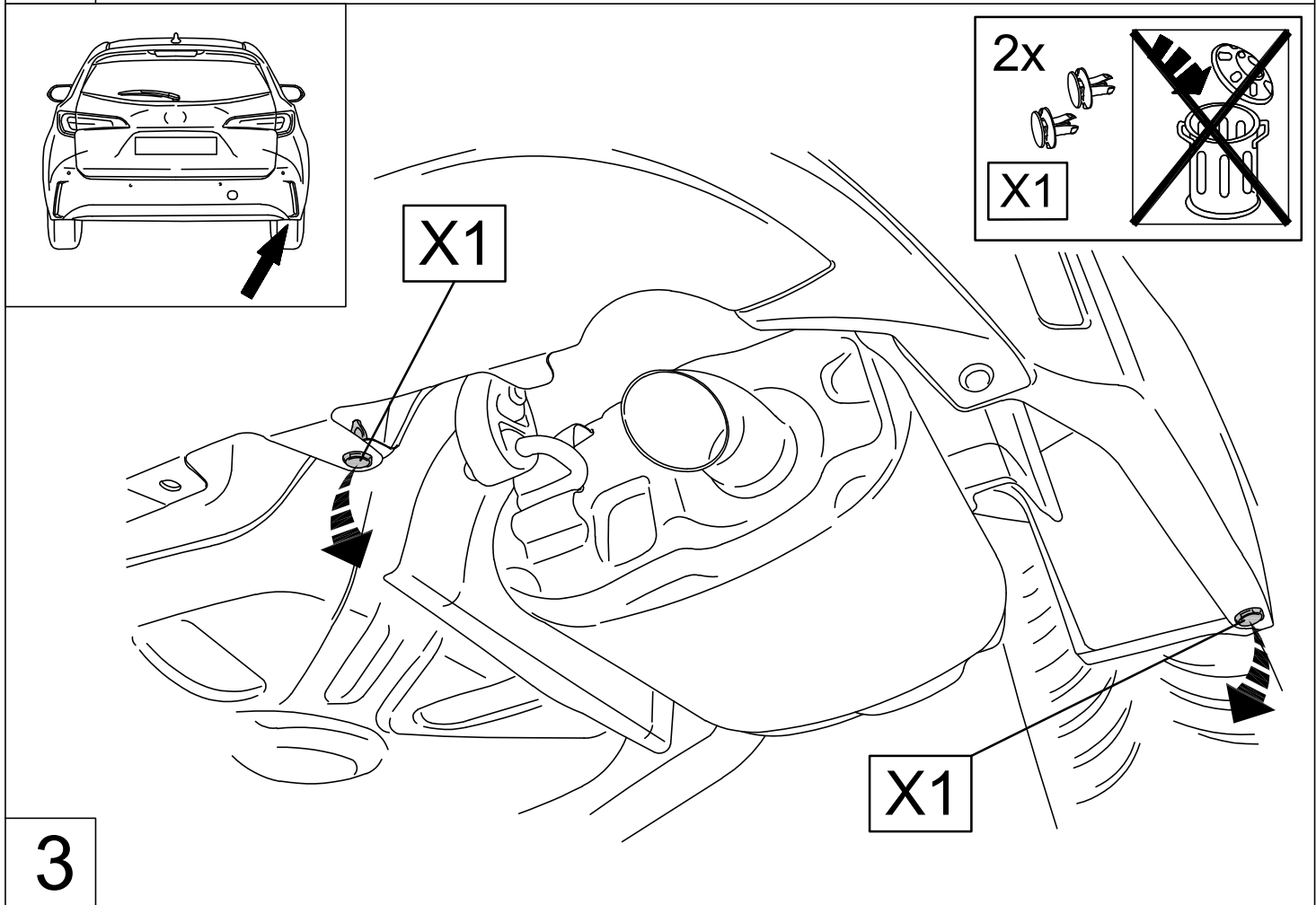
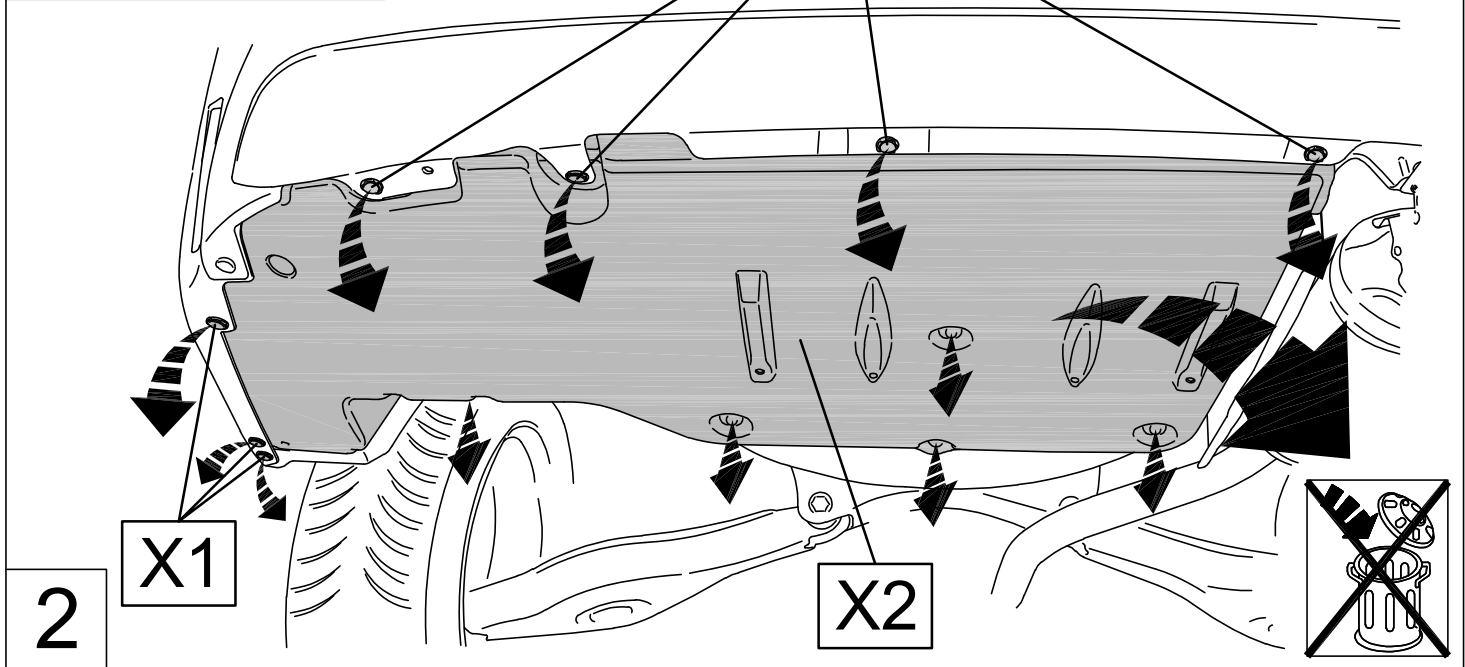
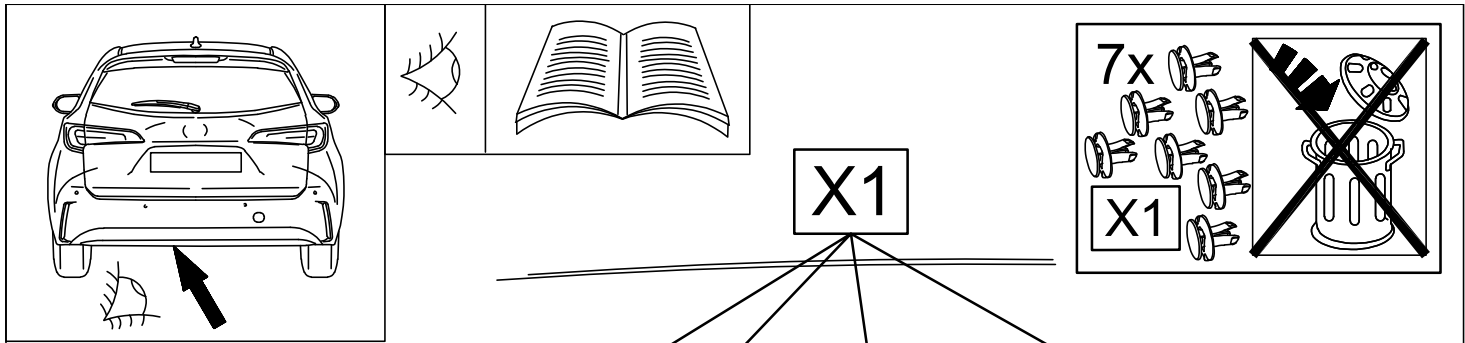

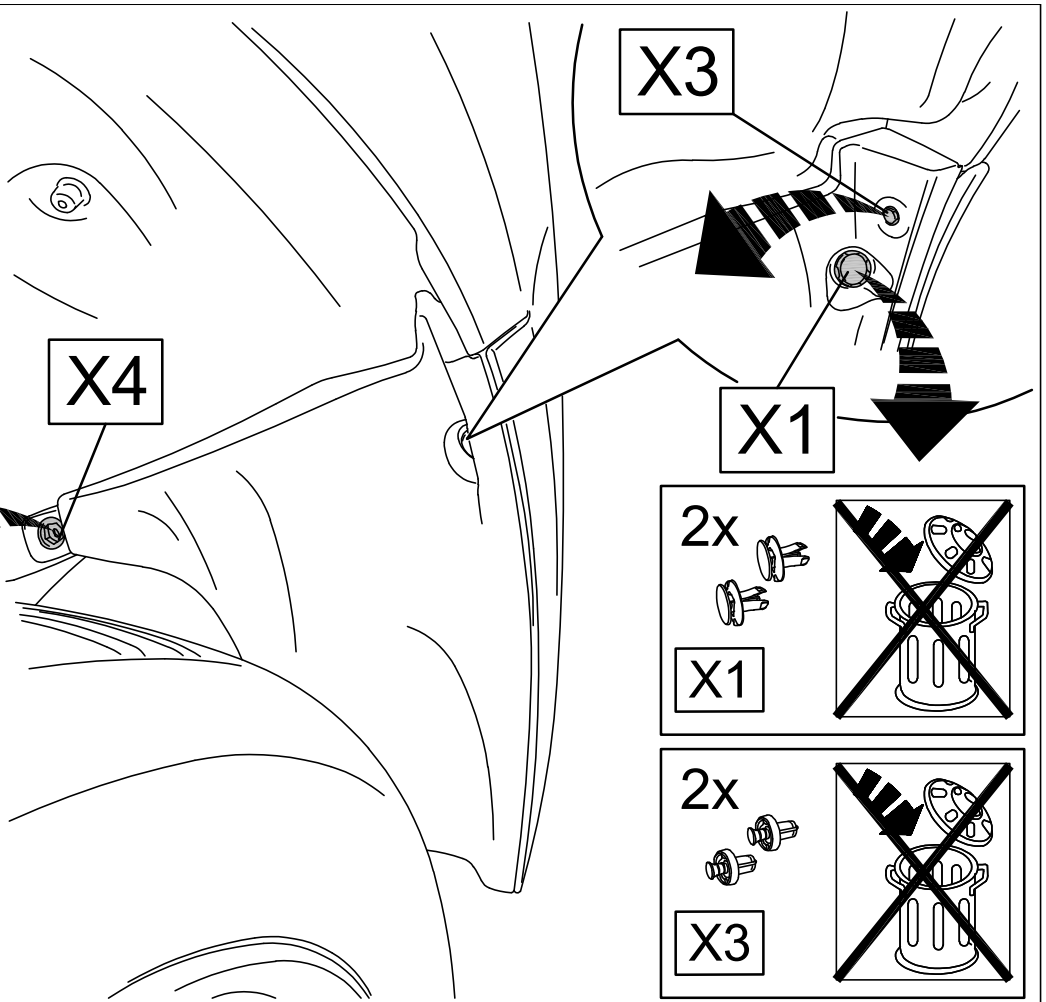
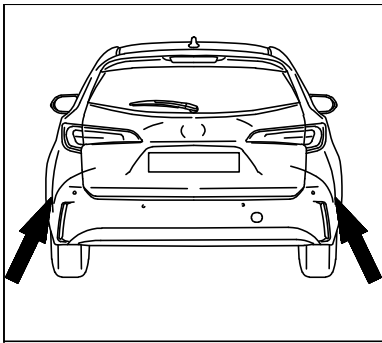

4

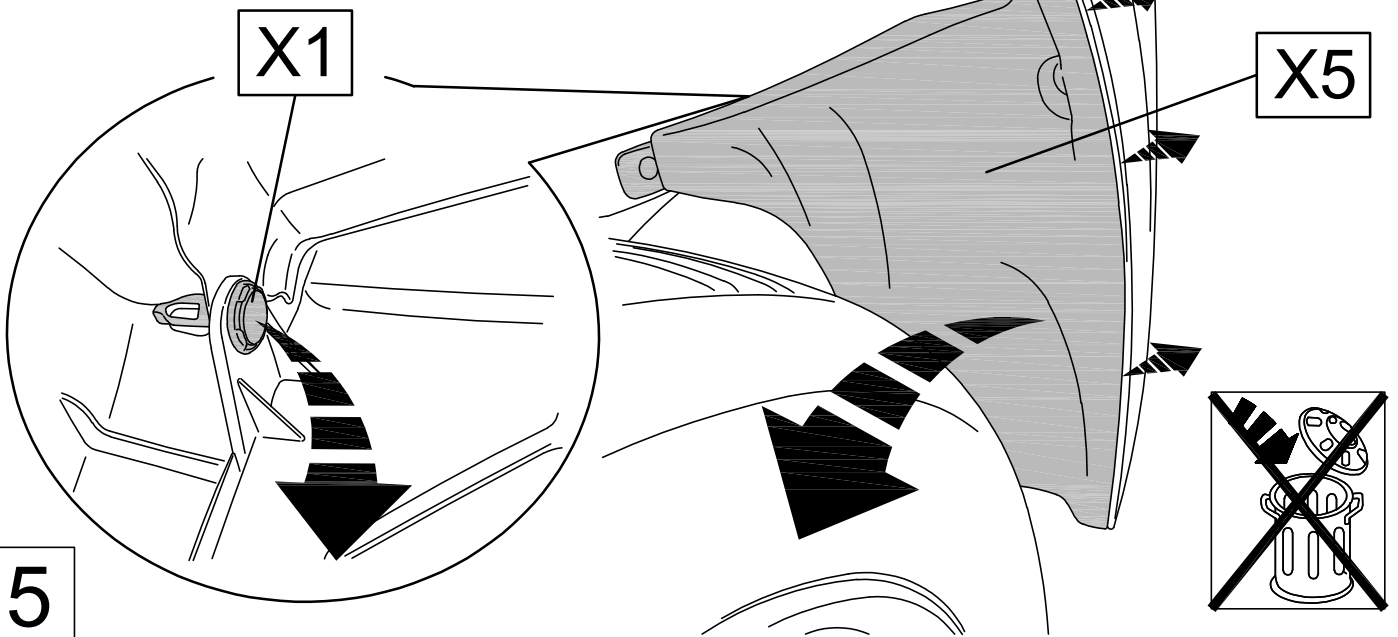
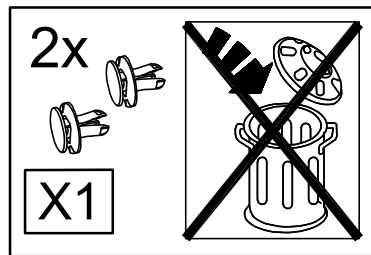
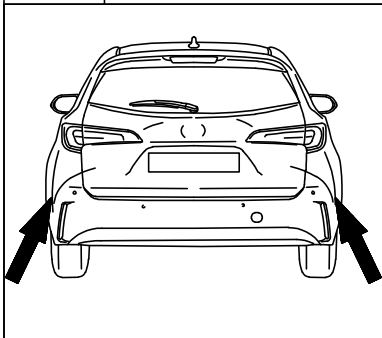

5

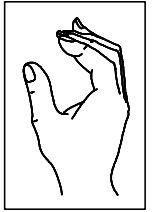
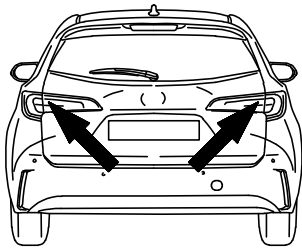

X6

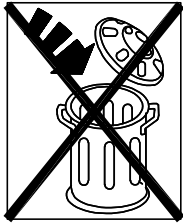

6

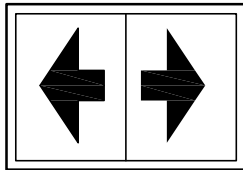
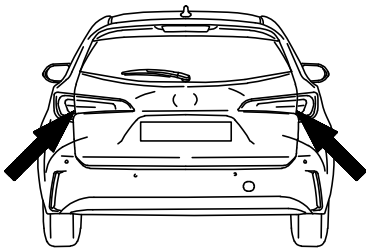
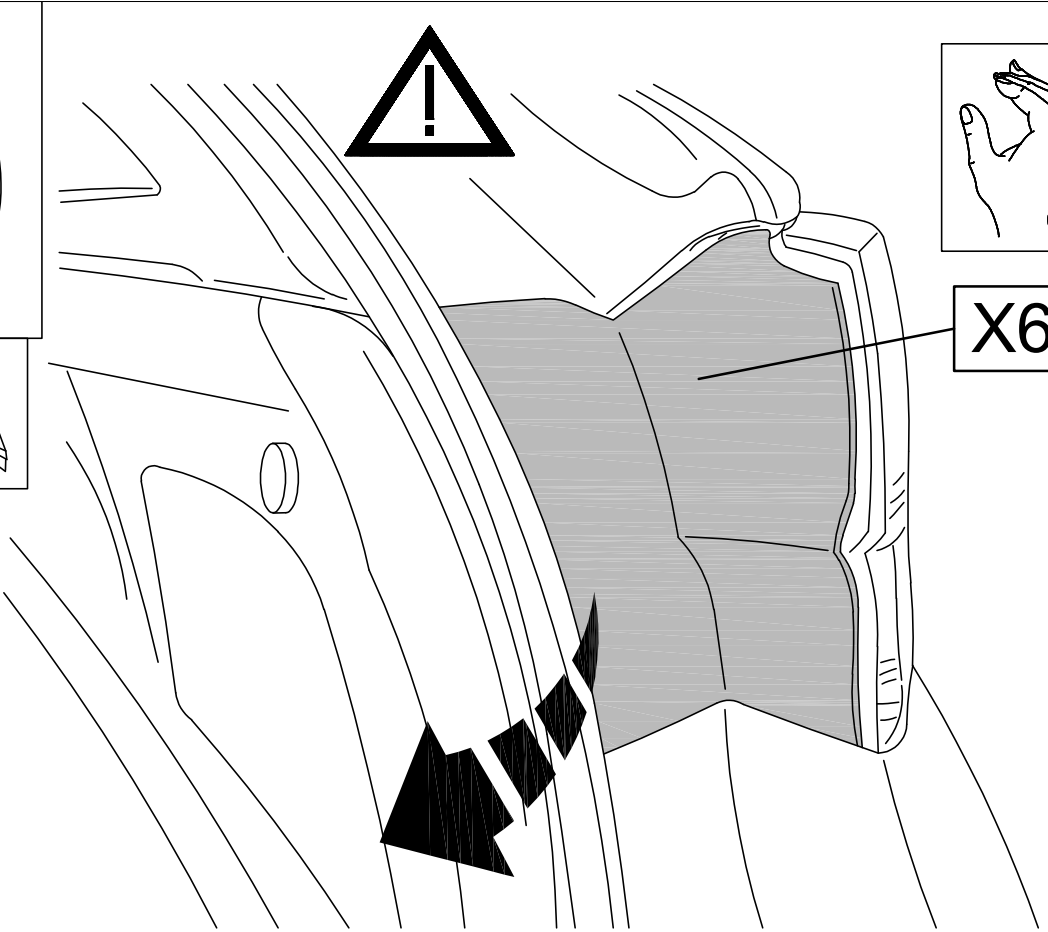

X7

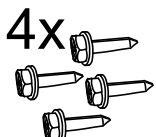

X7

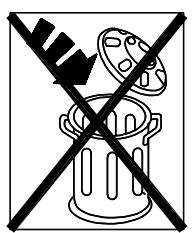

X8

7

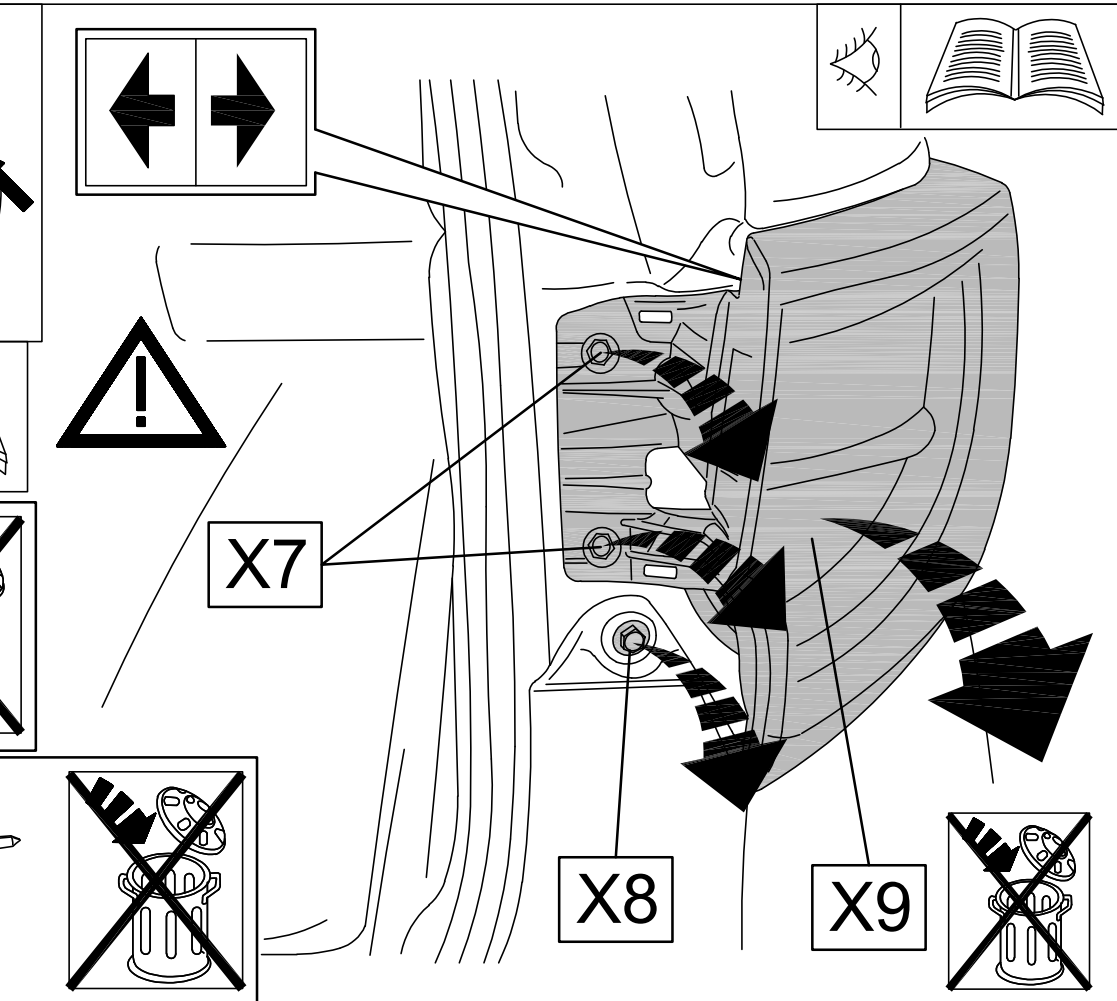

X8

X9

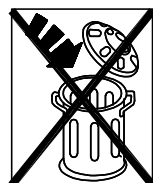

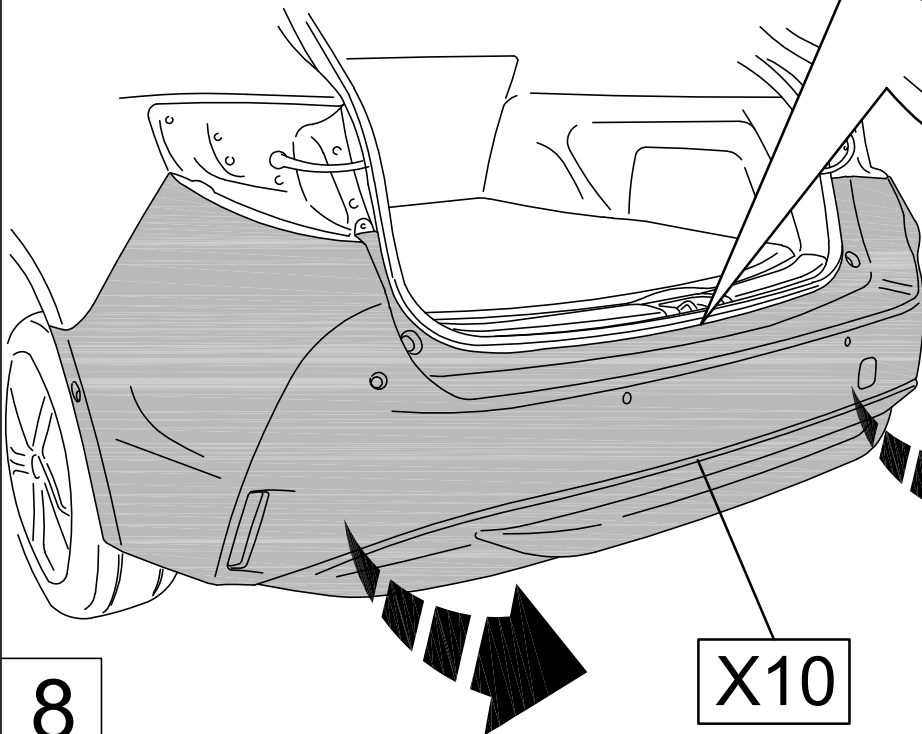
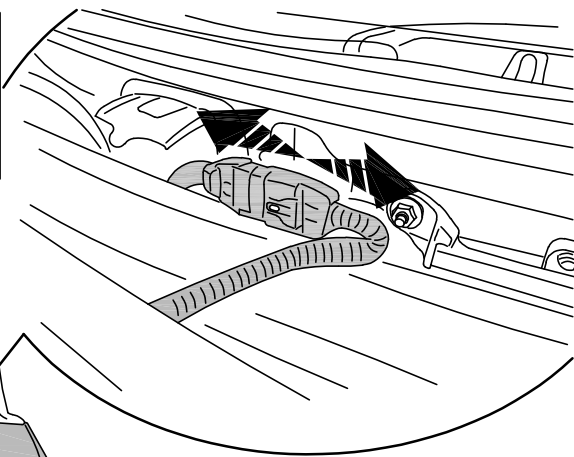
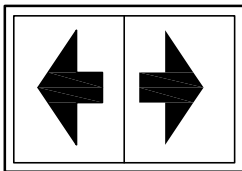

8

X10

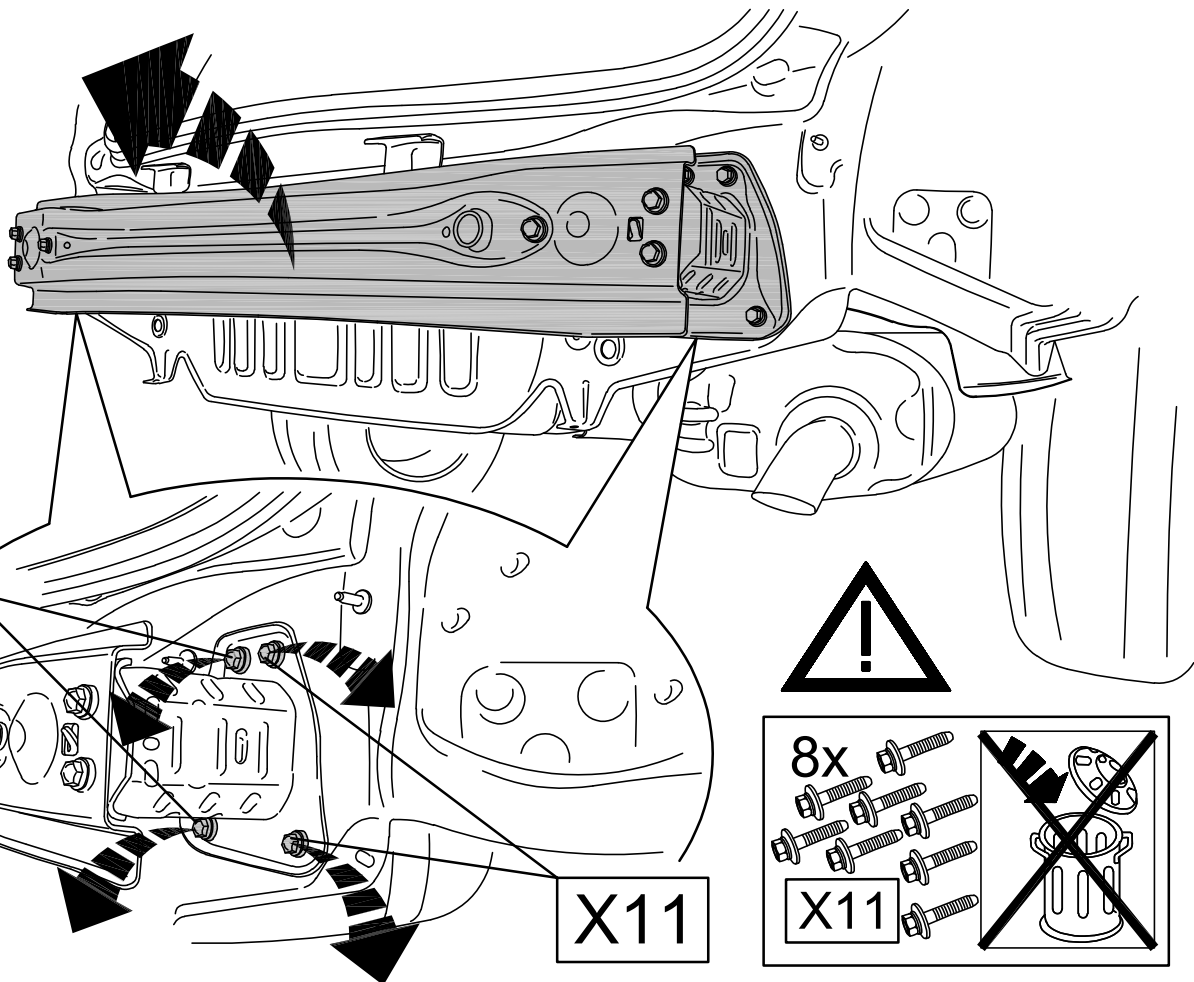
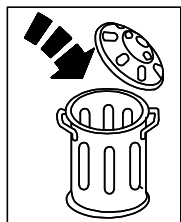
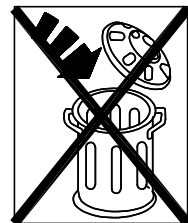

X11

X11

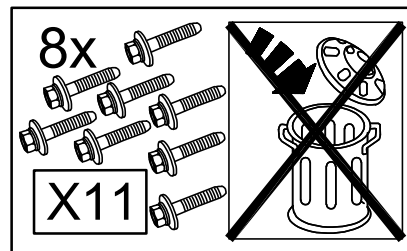

9

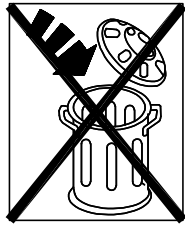
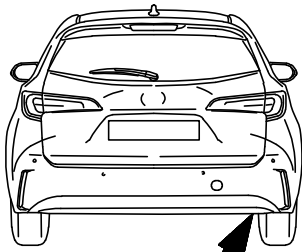

10

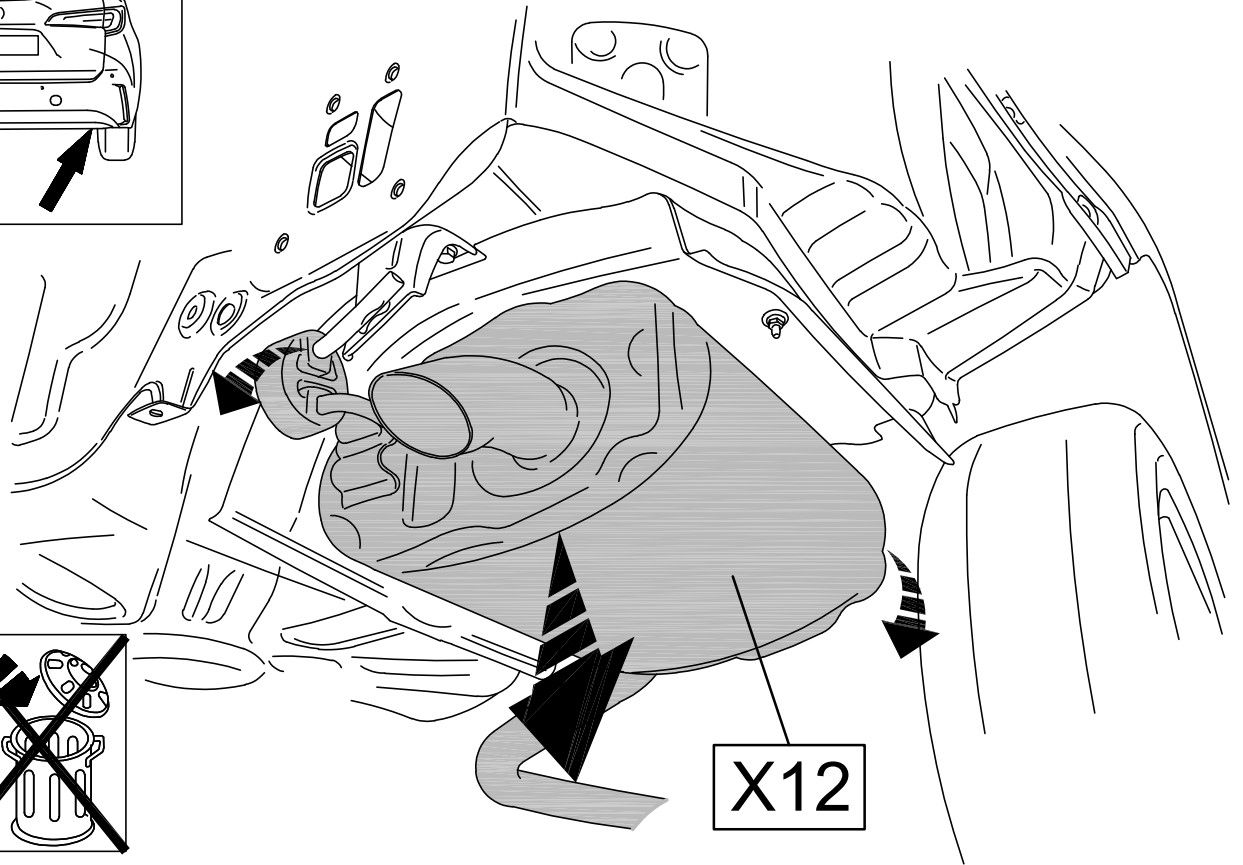

X12

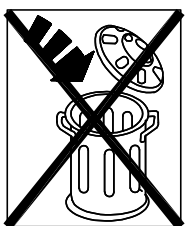
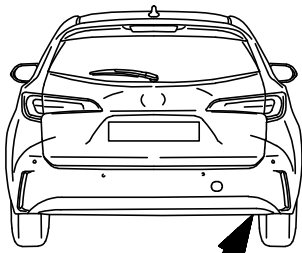

11

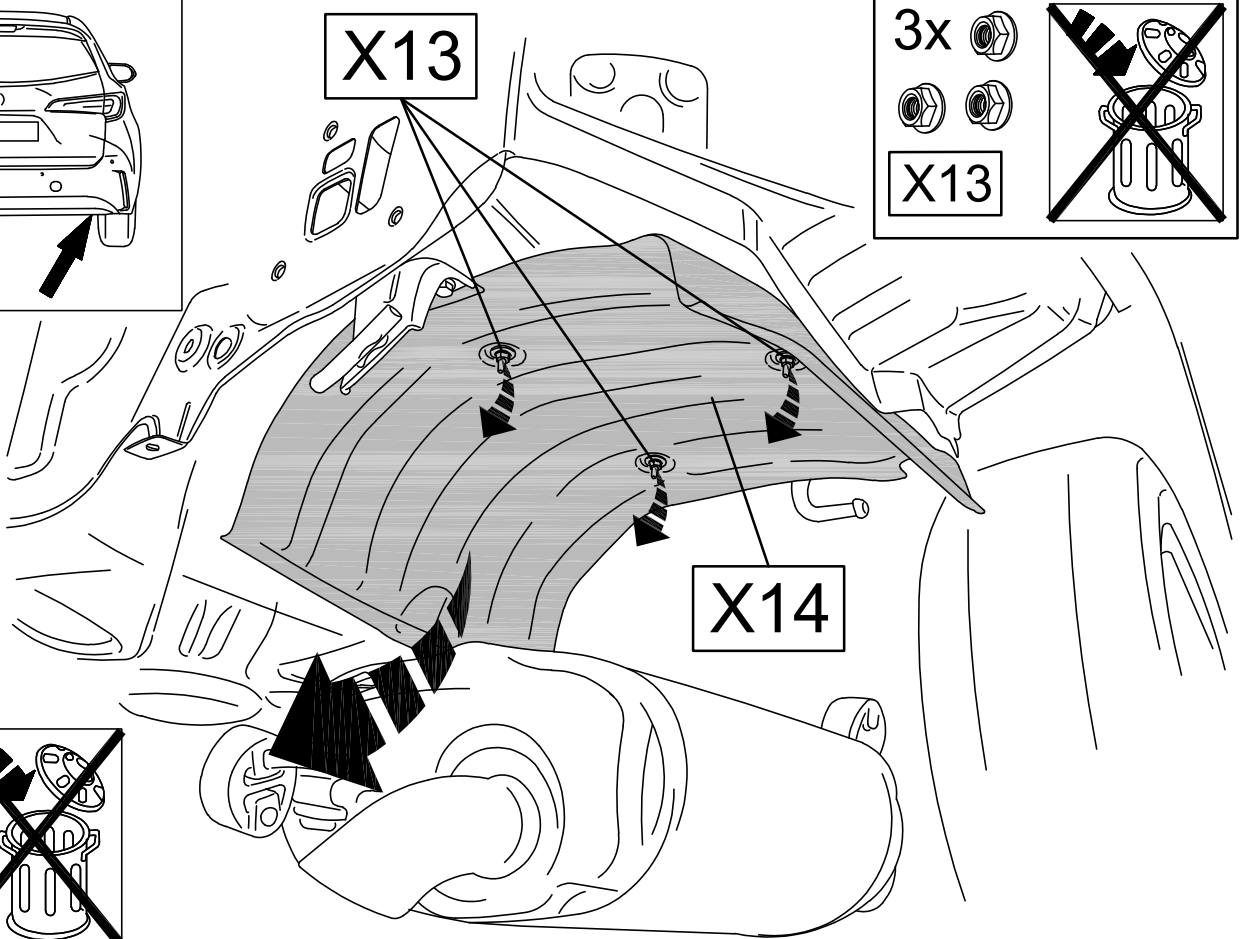

X13

3x

X13

X14

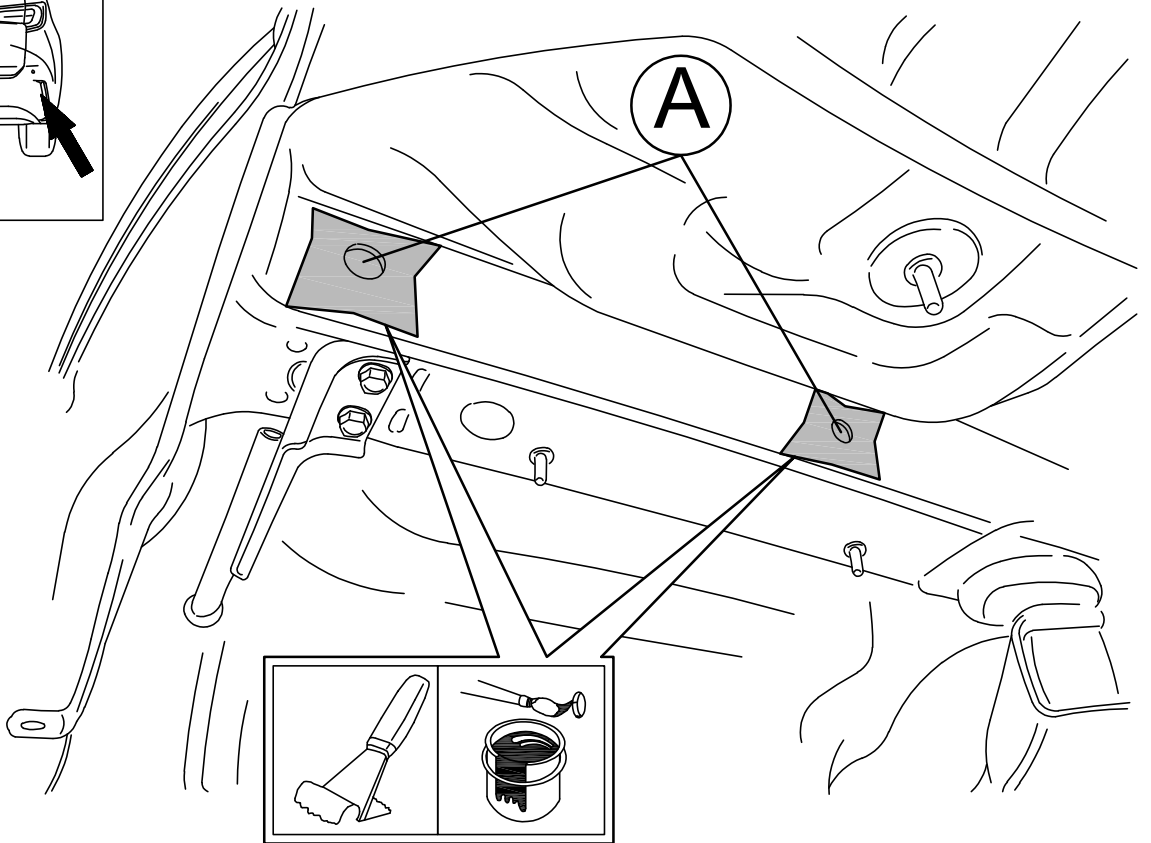
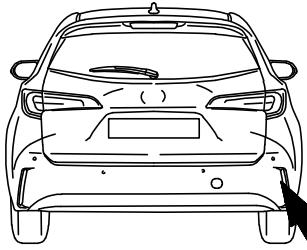

12

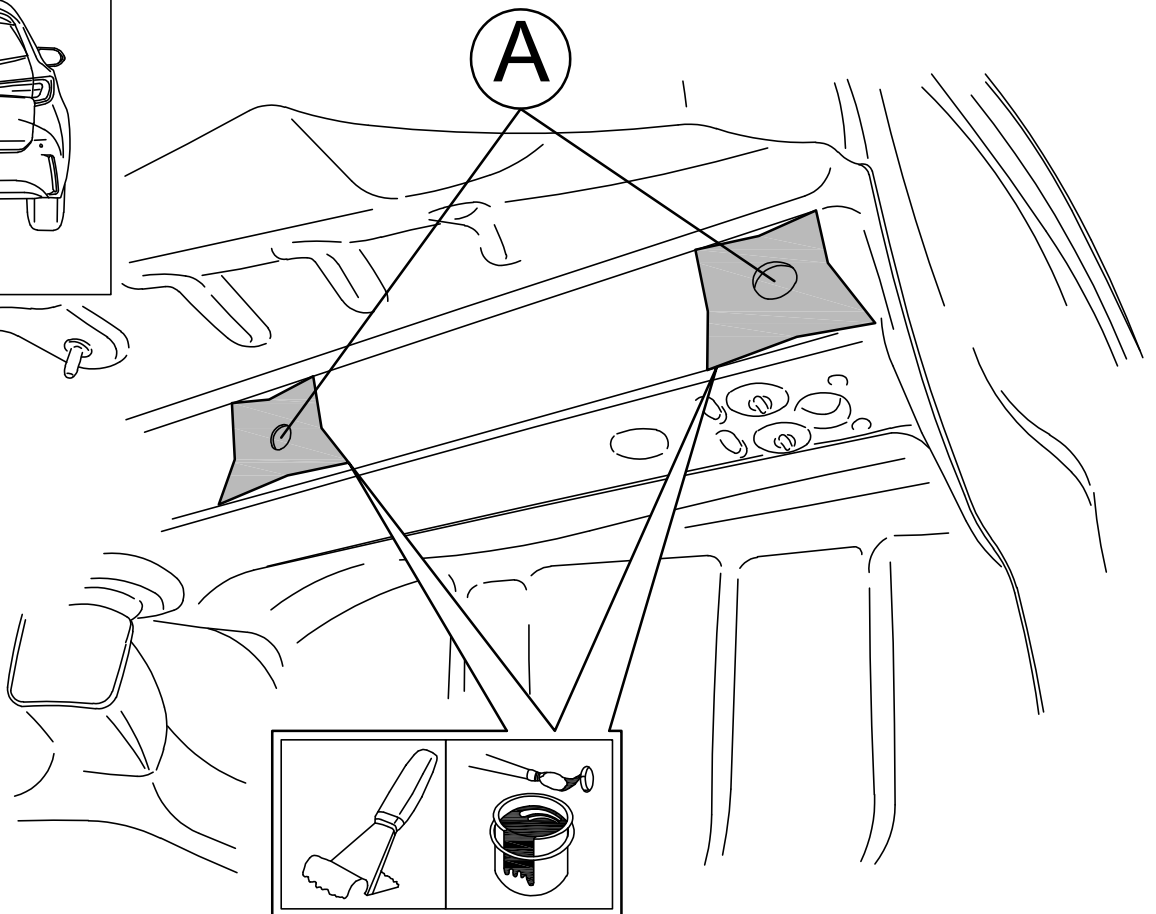
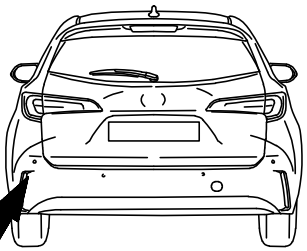

13

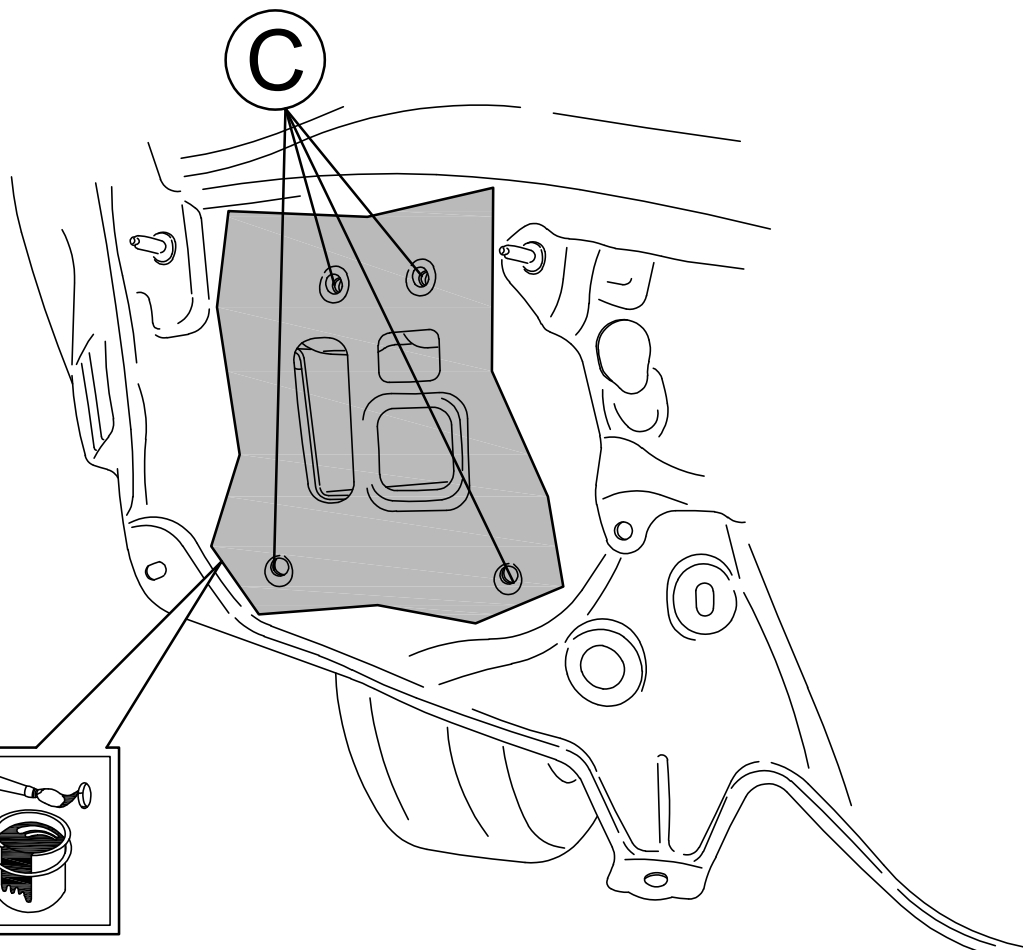
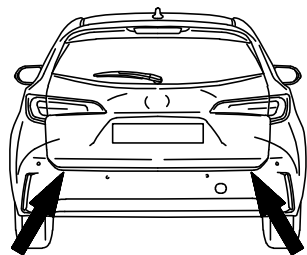

14

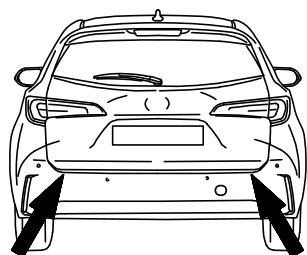

1

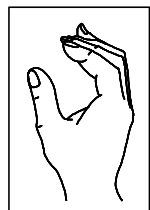

3

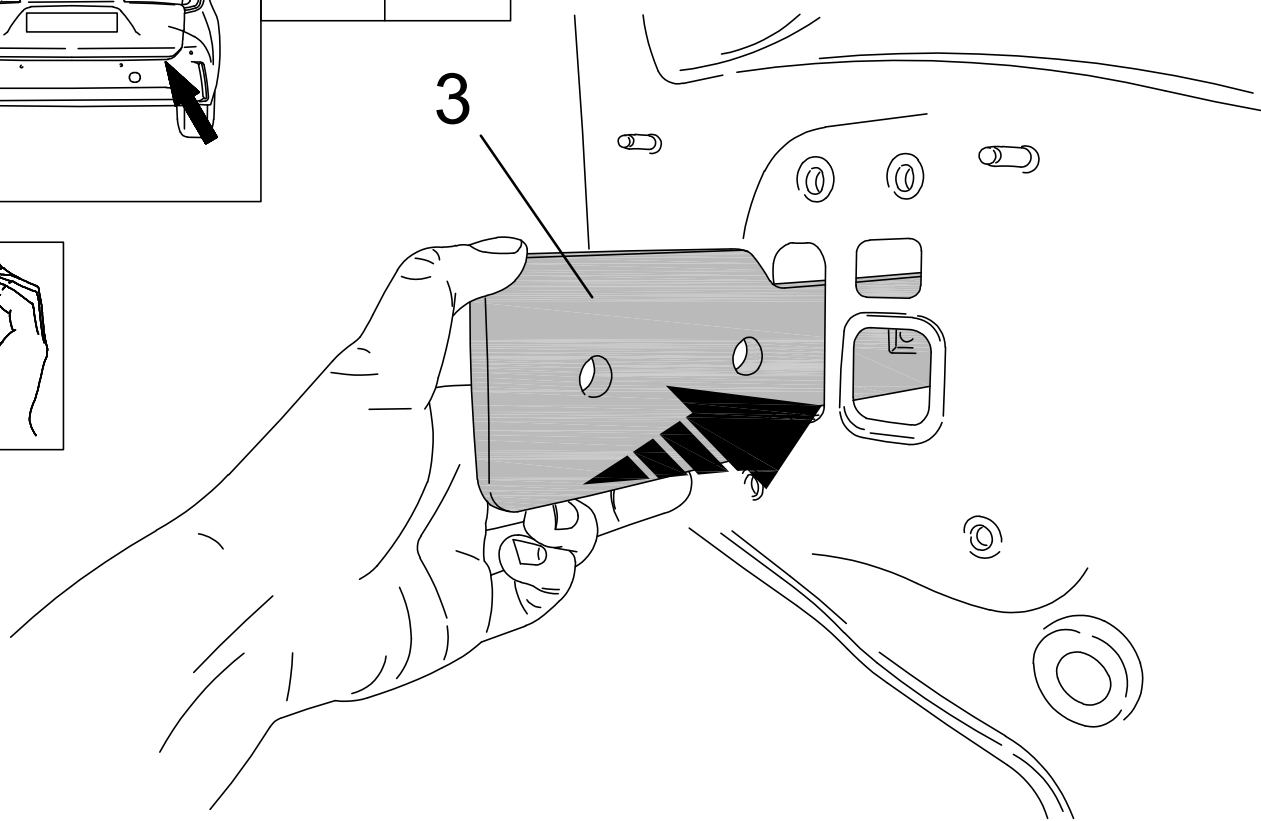

15

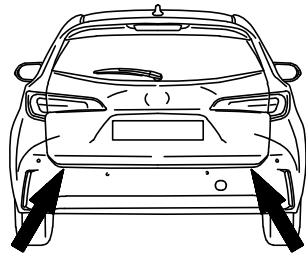

1

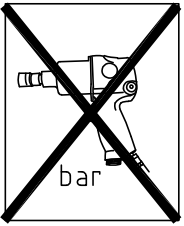
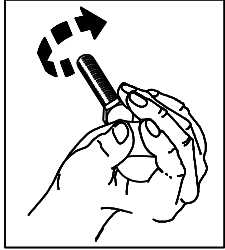
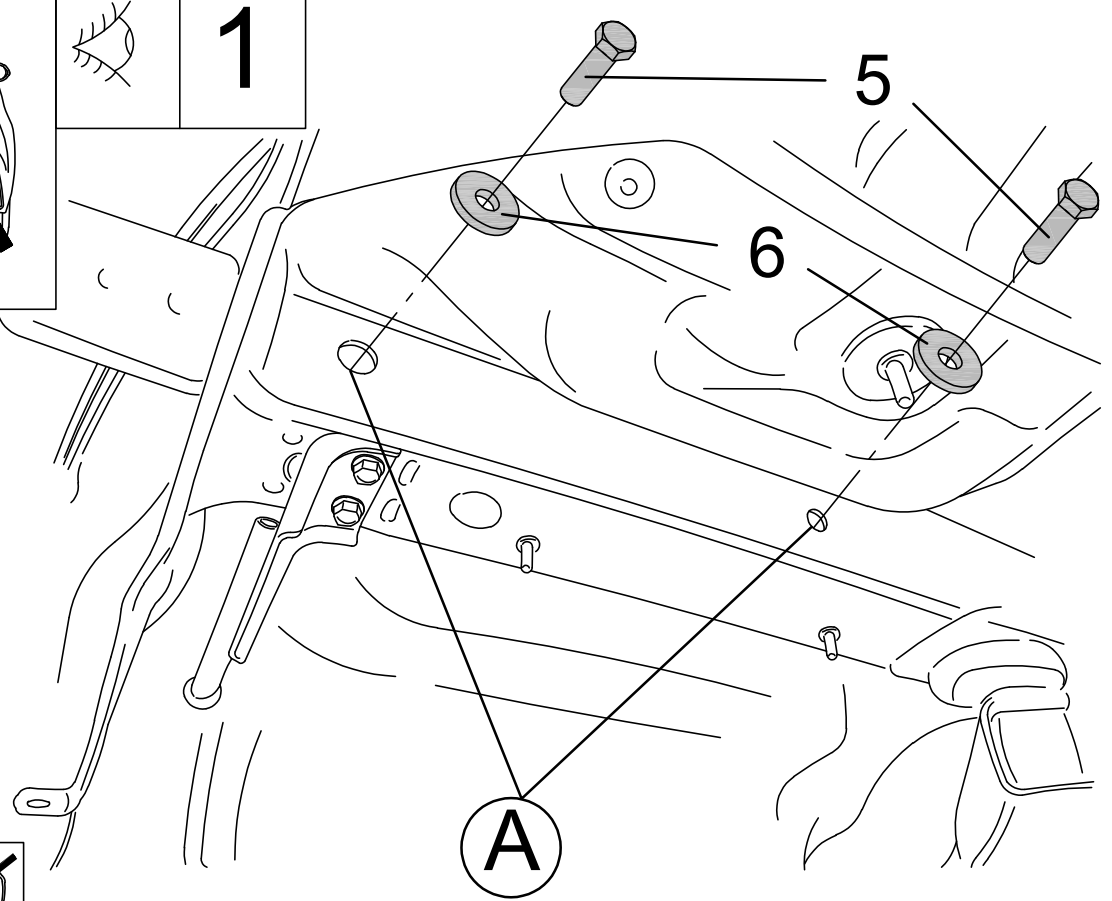

16

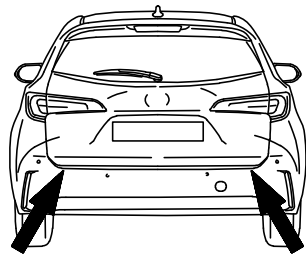
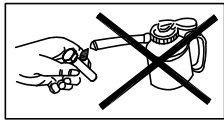

1



9

C

4

X11

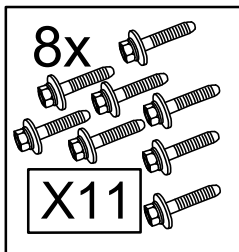

17

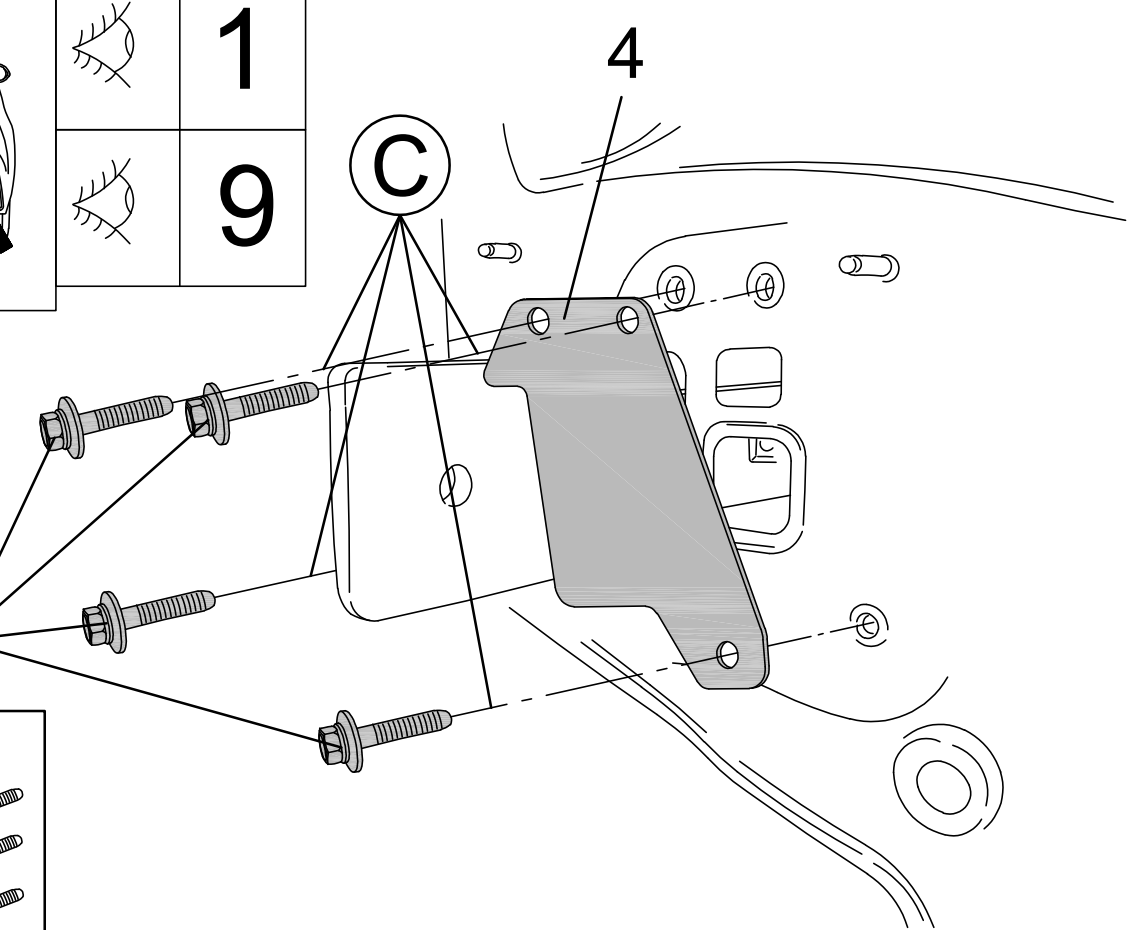

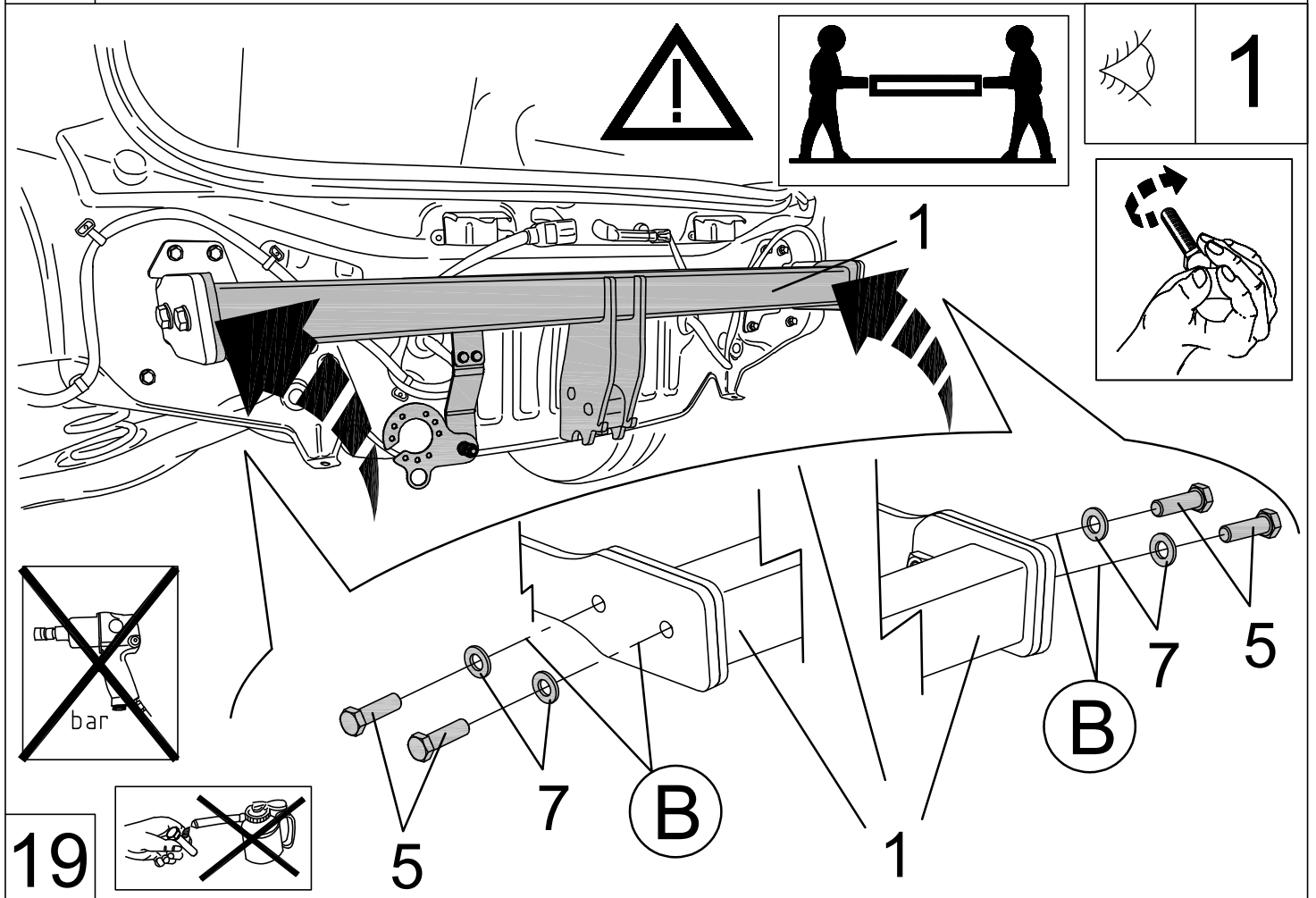
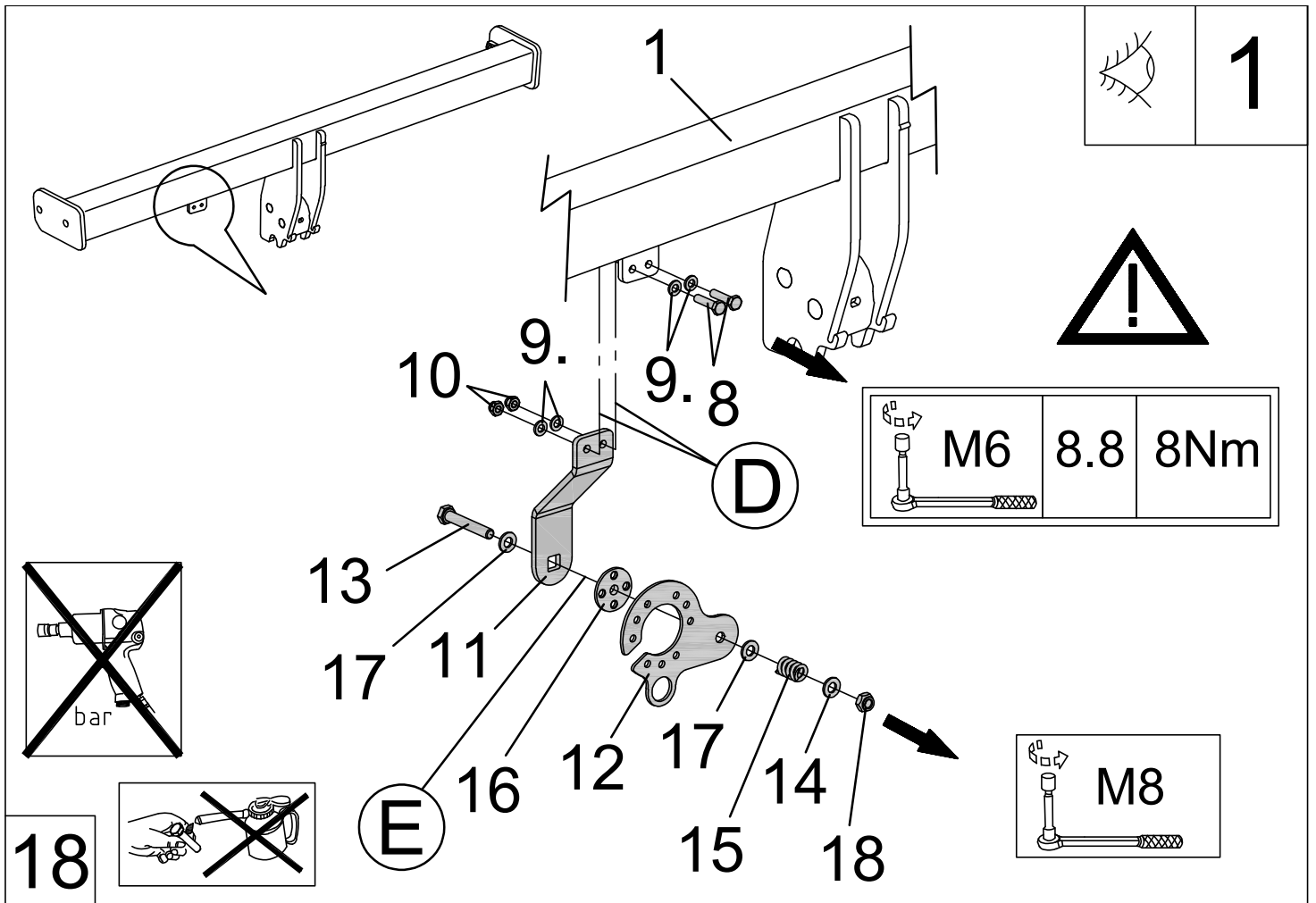

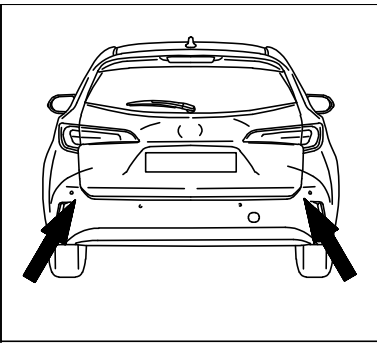

	M12	10.9	100Nm
--	------------	-------------	--------------

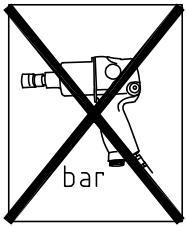

20

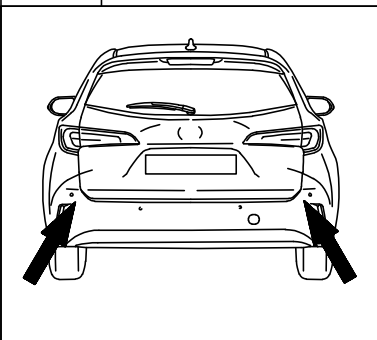
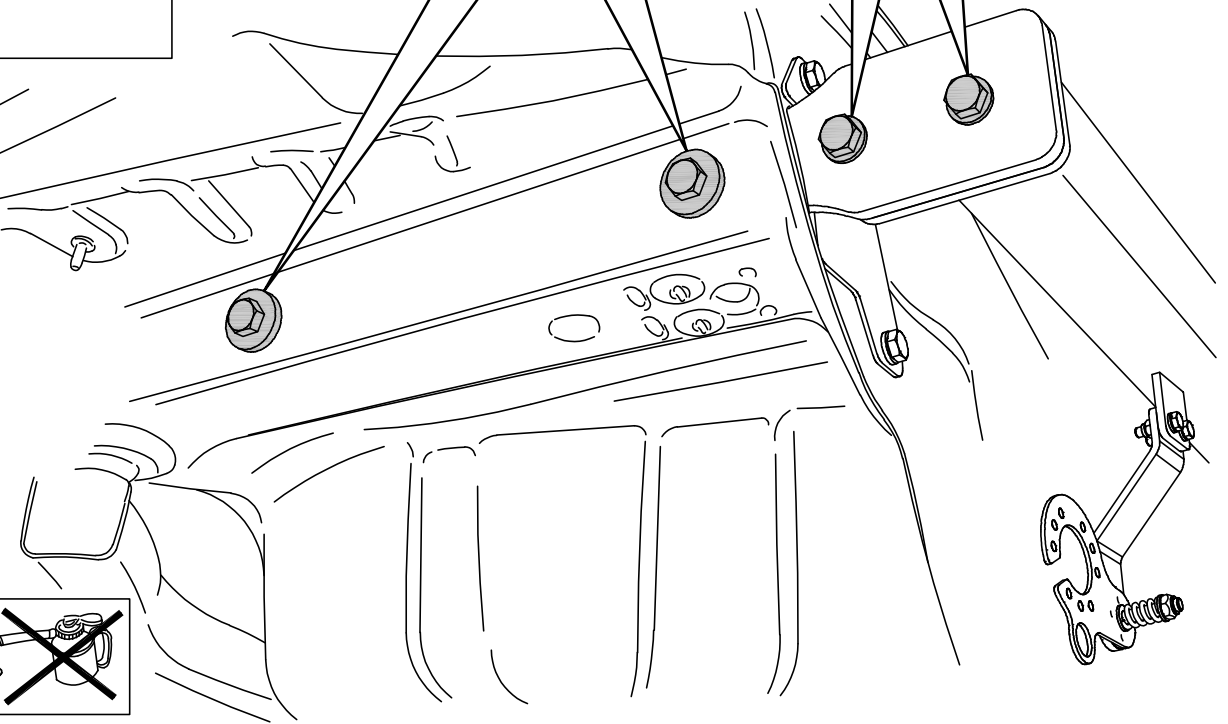
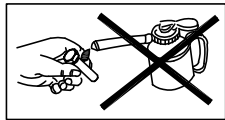

	M8	8.8	20Nm
--	-----------	------------	-------------

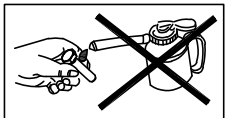
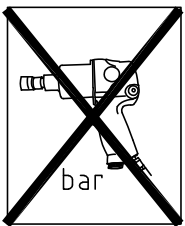

21

	M8	8.8	20Nm
--	-----------	------------	-------------

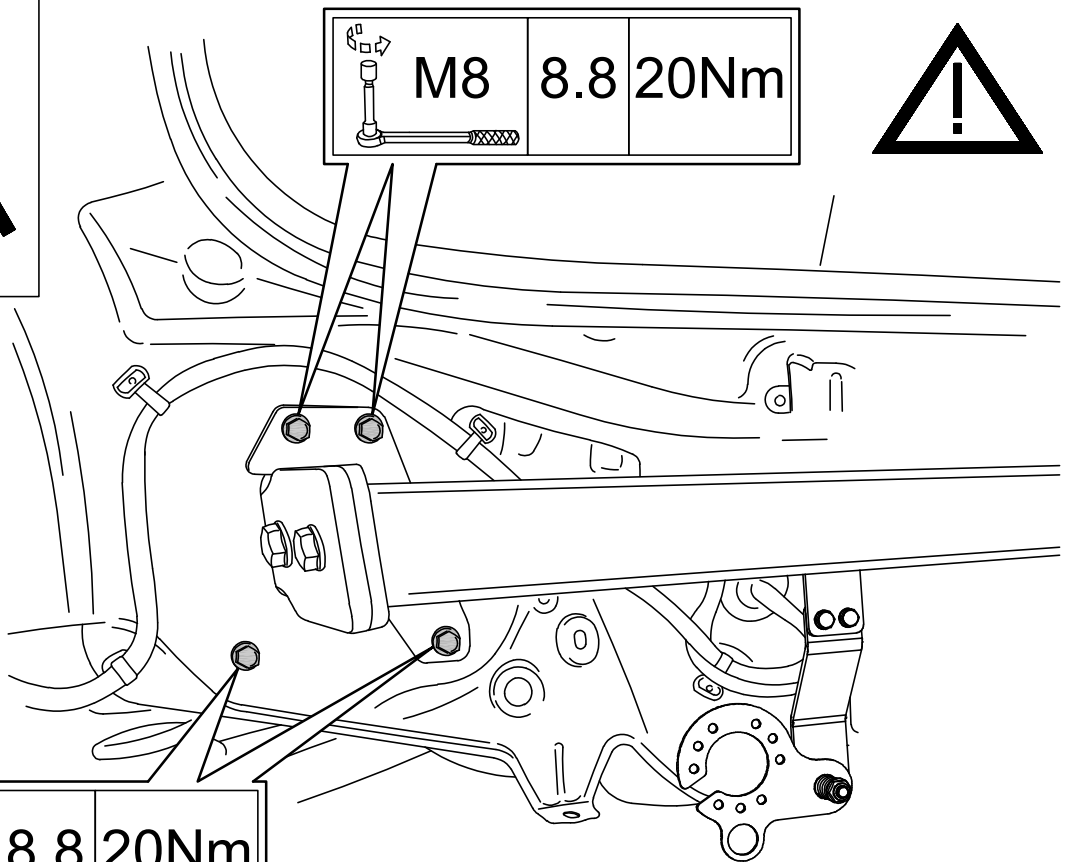

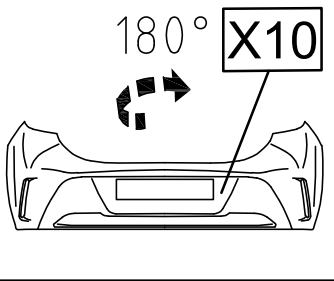

X10

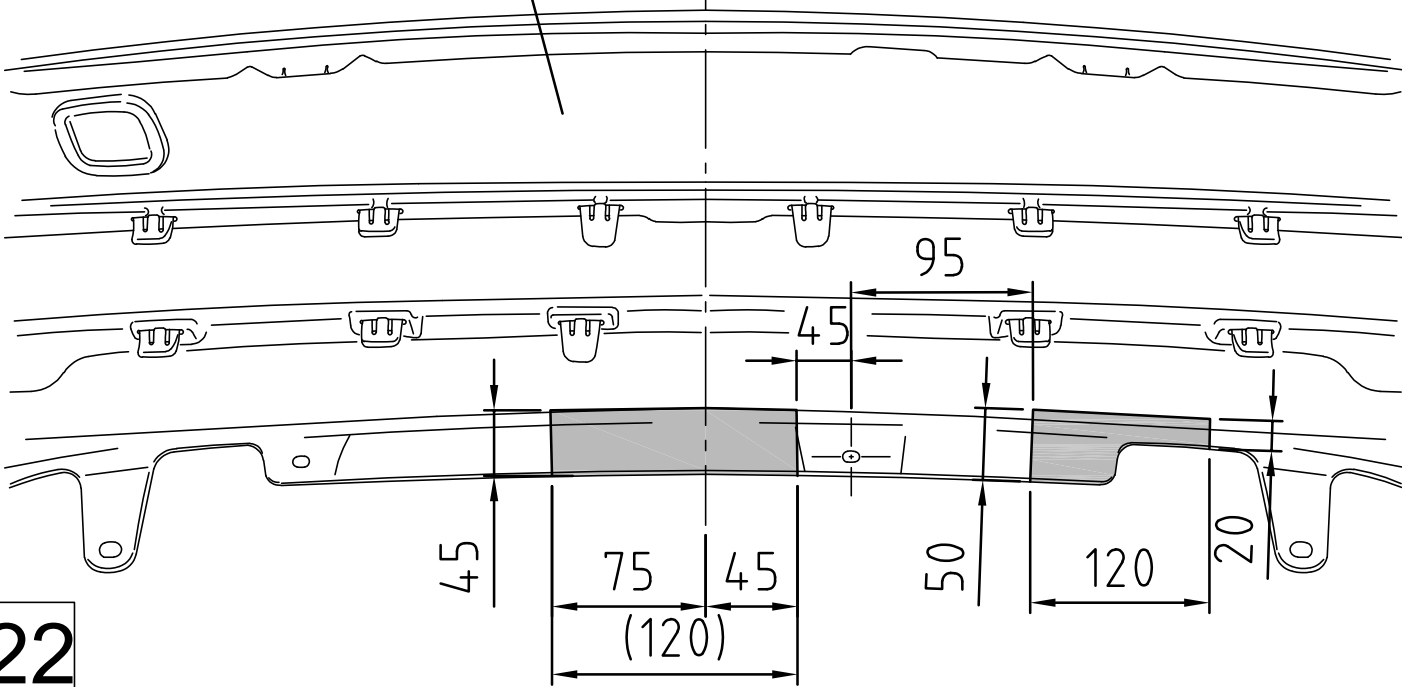
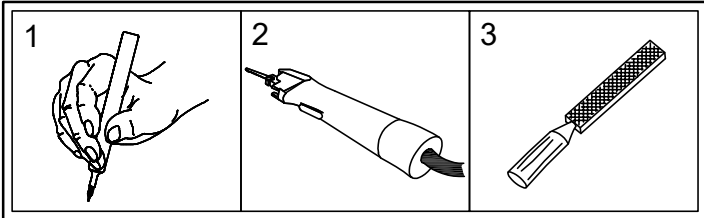

22

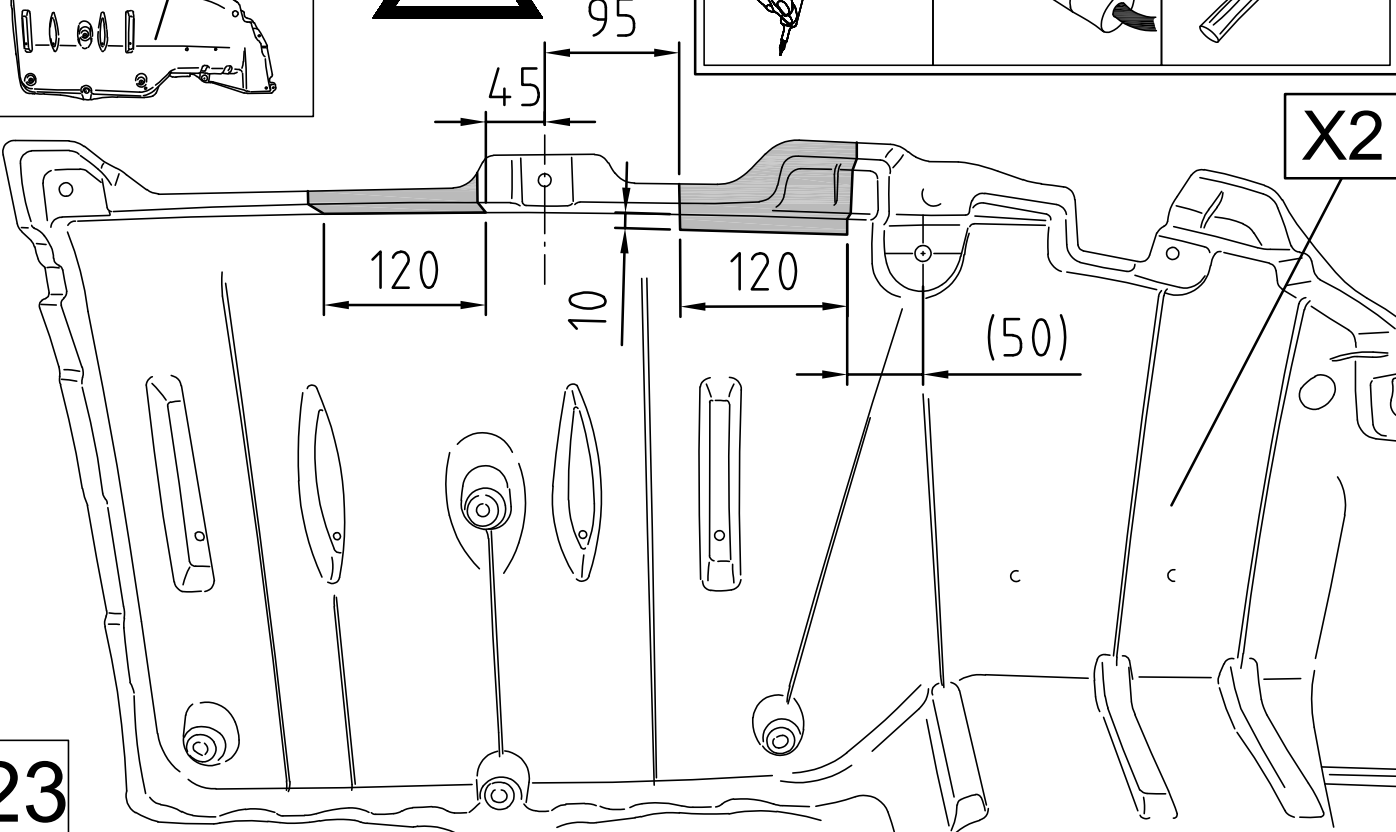
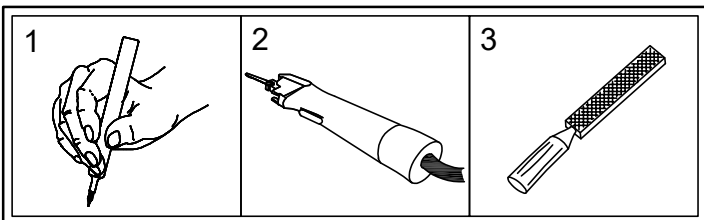
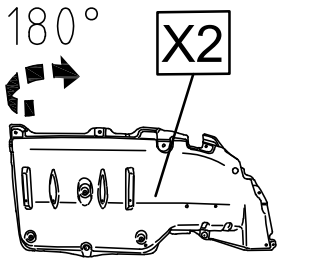

23

Vor der Komplettierung des Fahrzeuges ⚠ ist der Elektrosatz zu montieren! ⚠

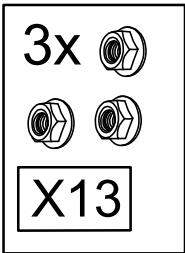
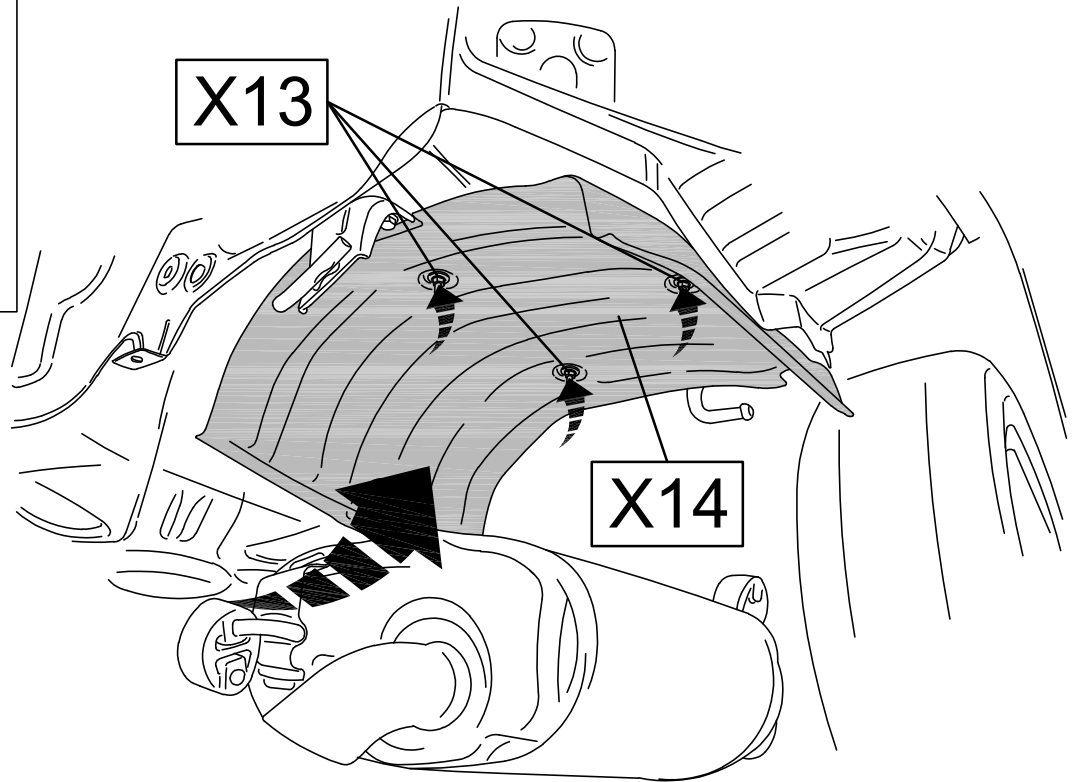
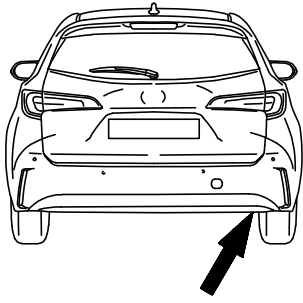

24

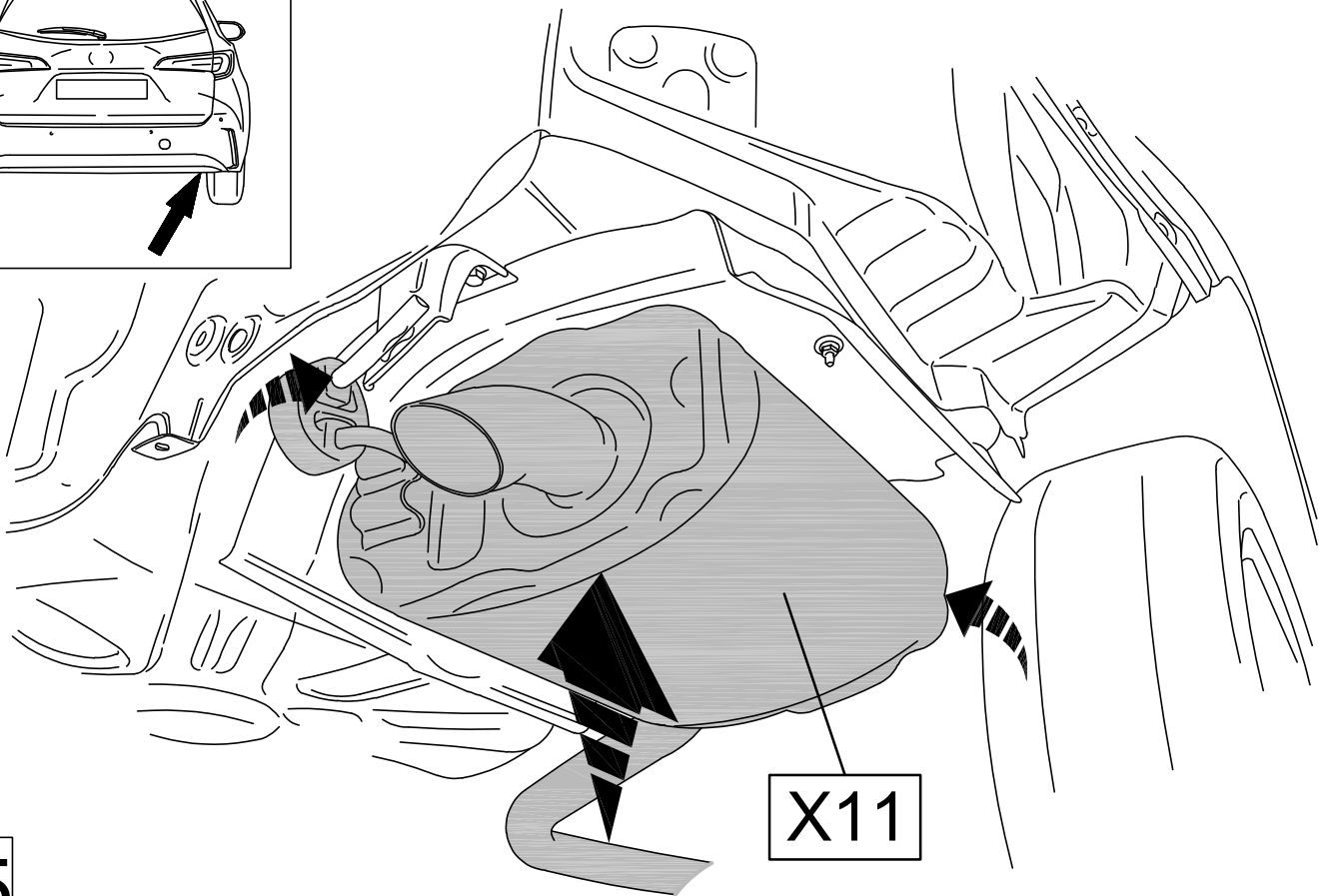
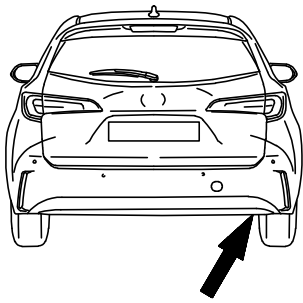

25

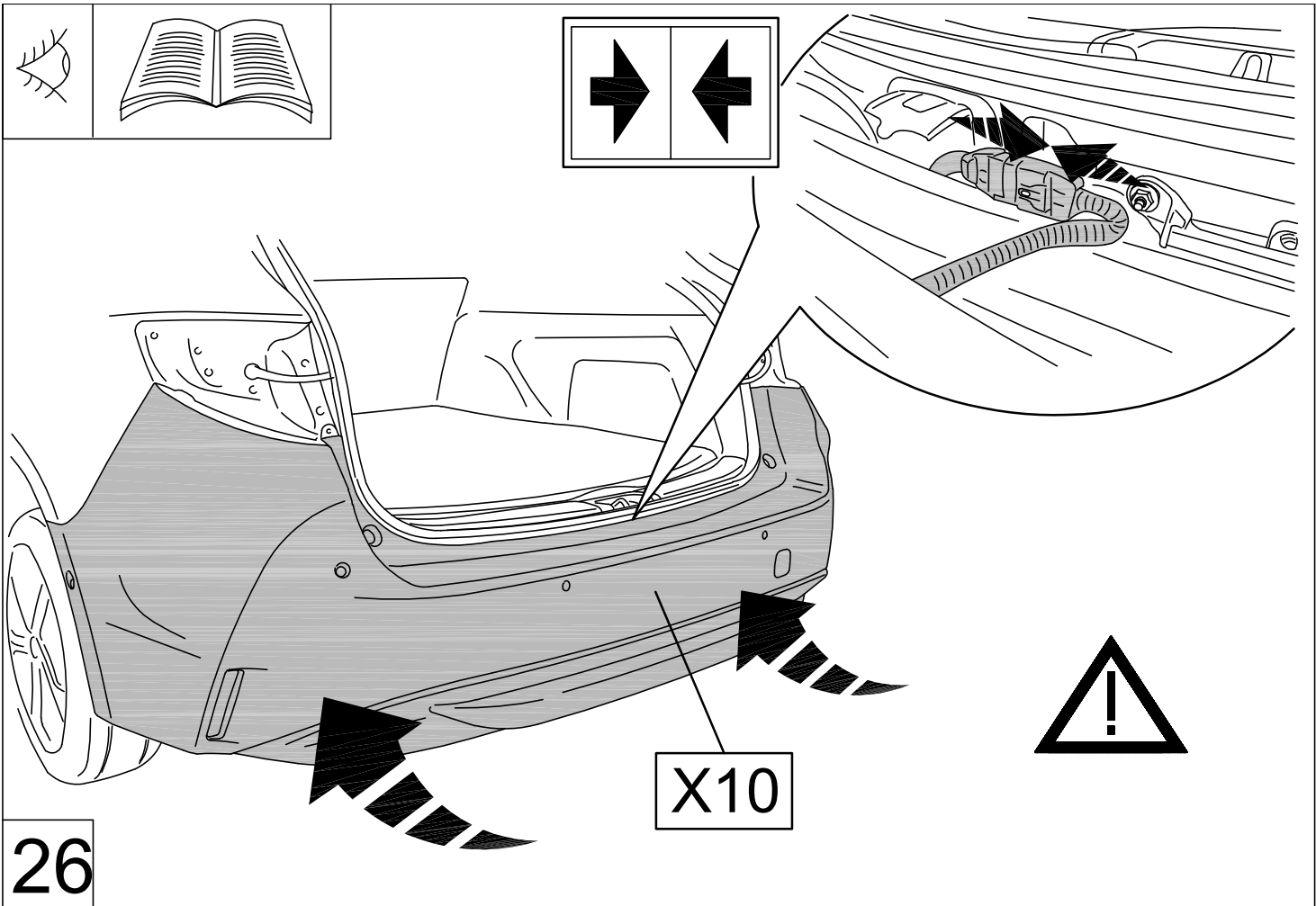

26

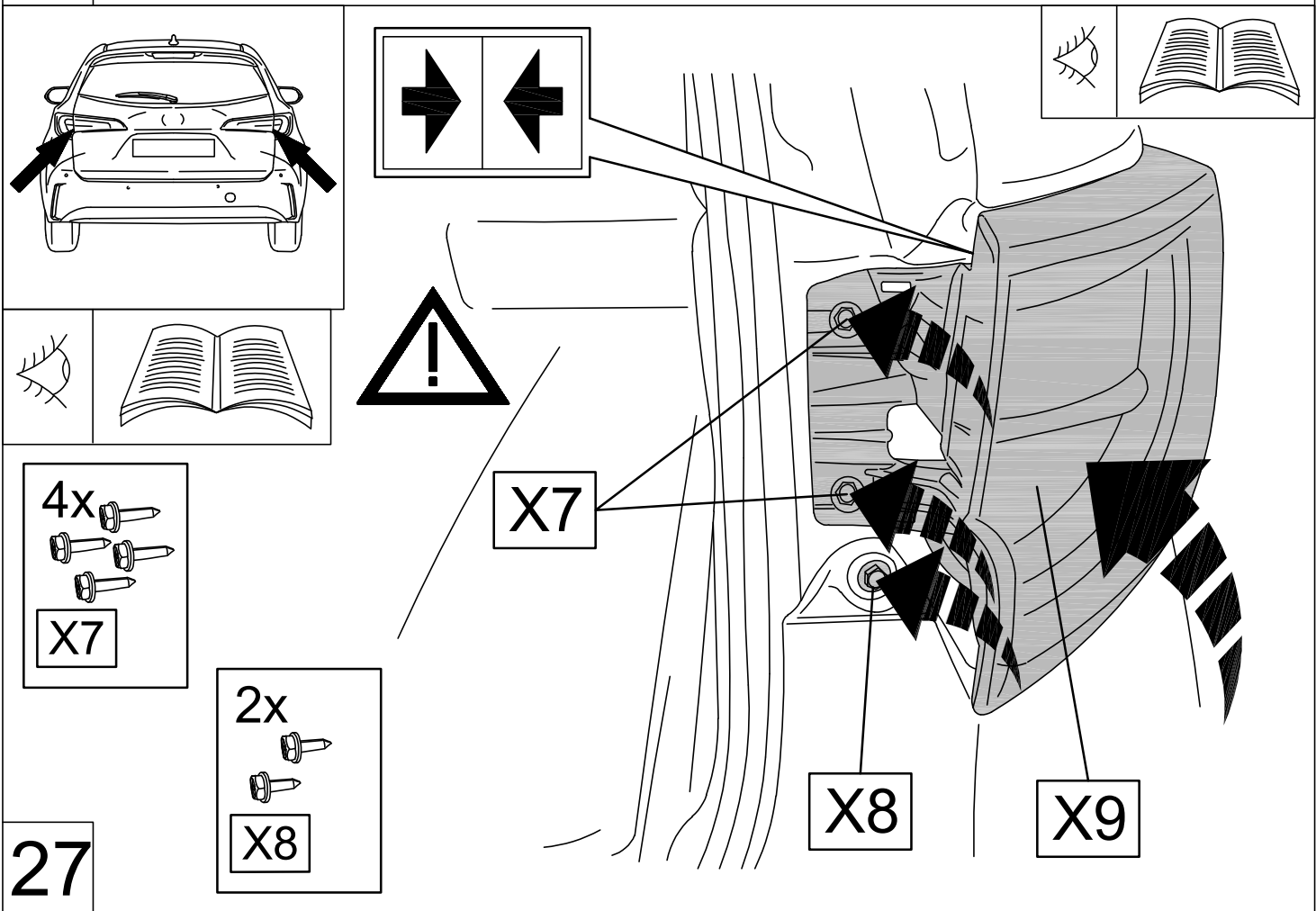

27

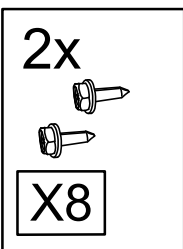
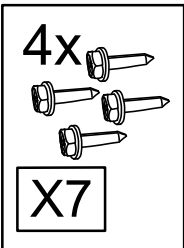

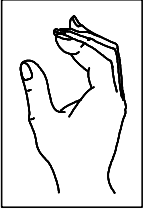
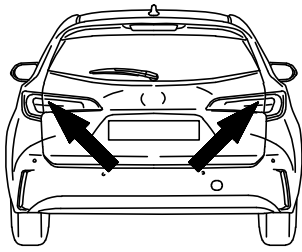

X6



28

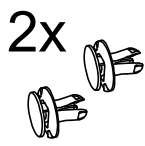
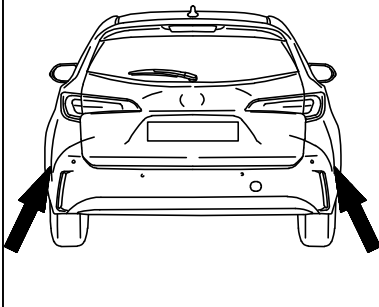
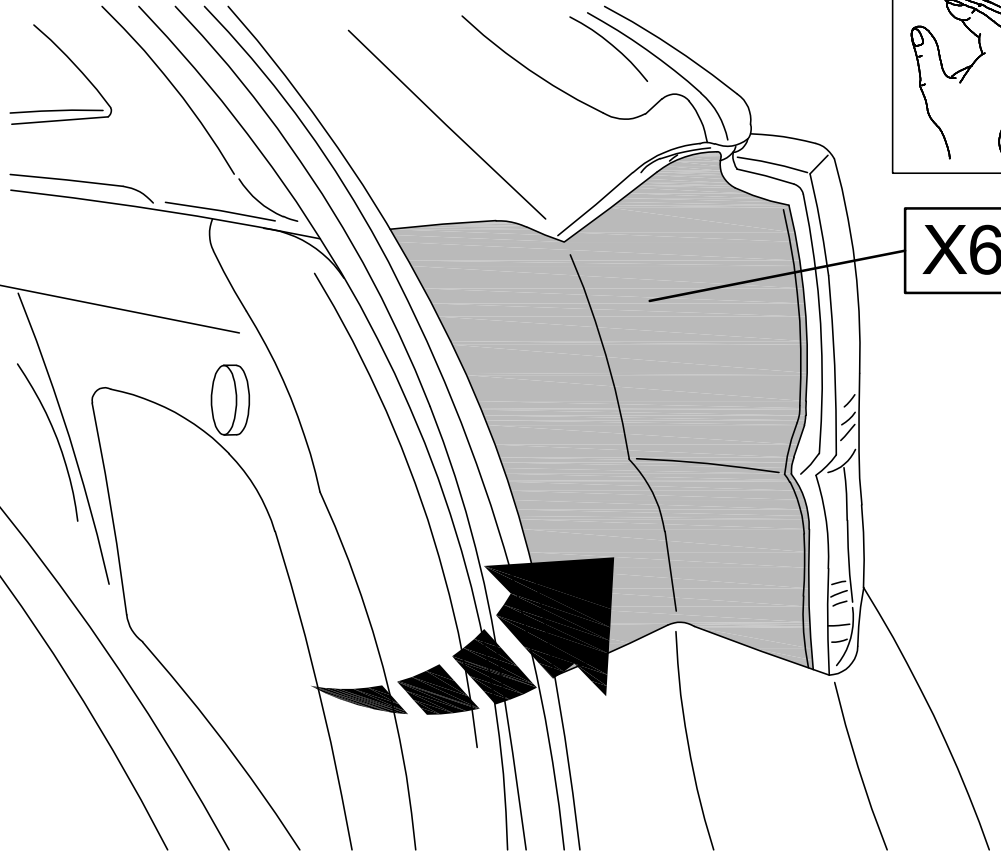

X1



X1

X5

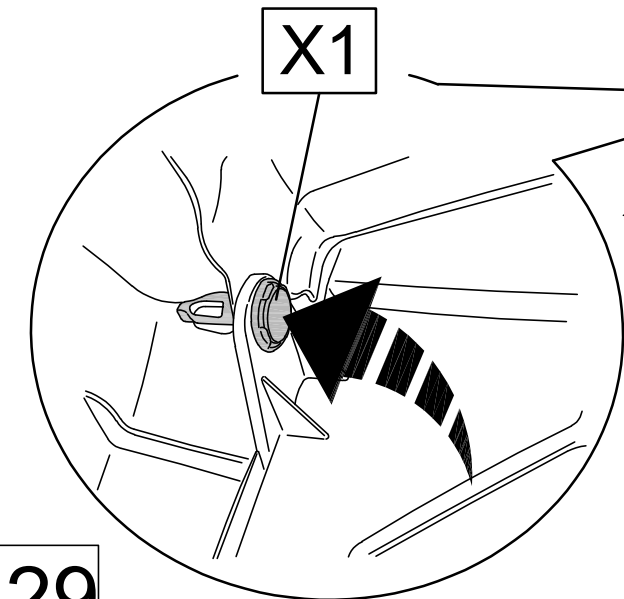

29

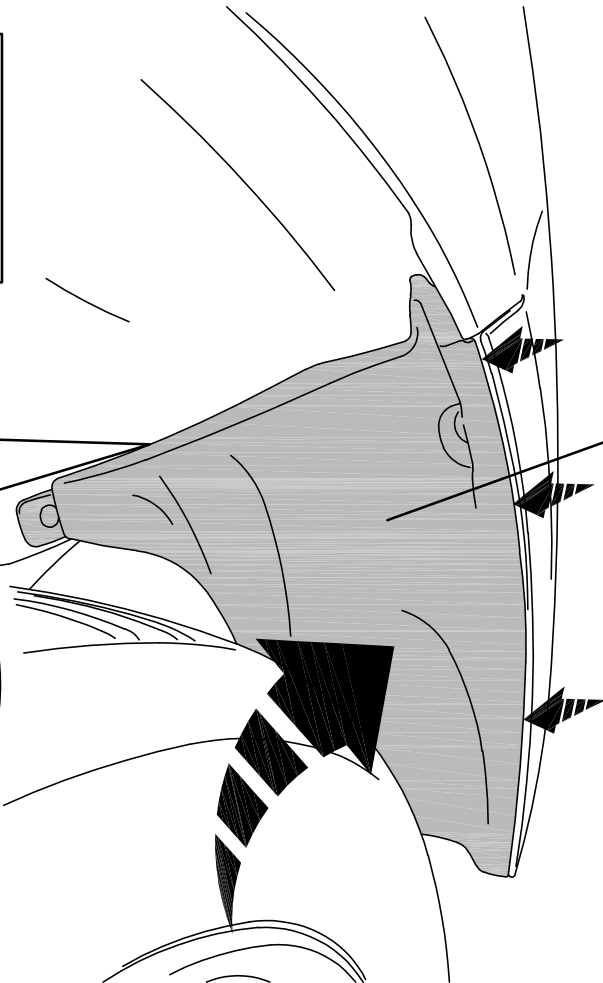

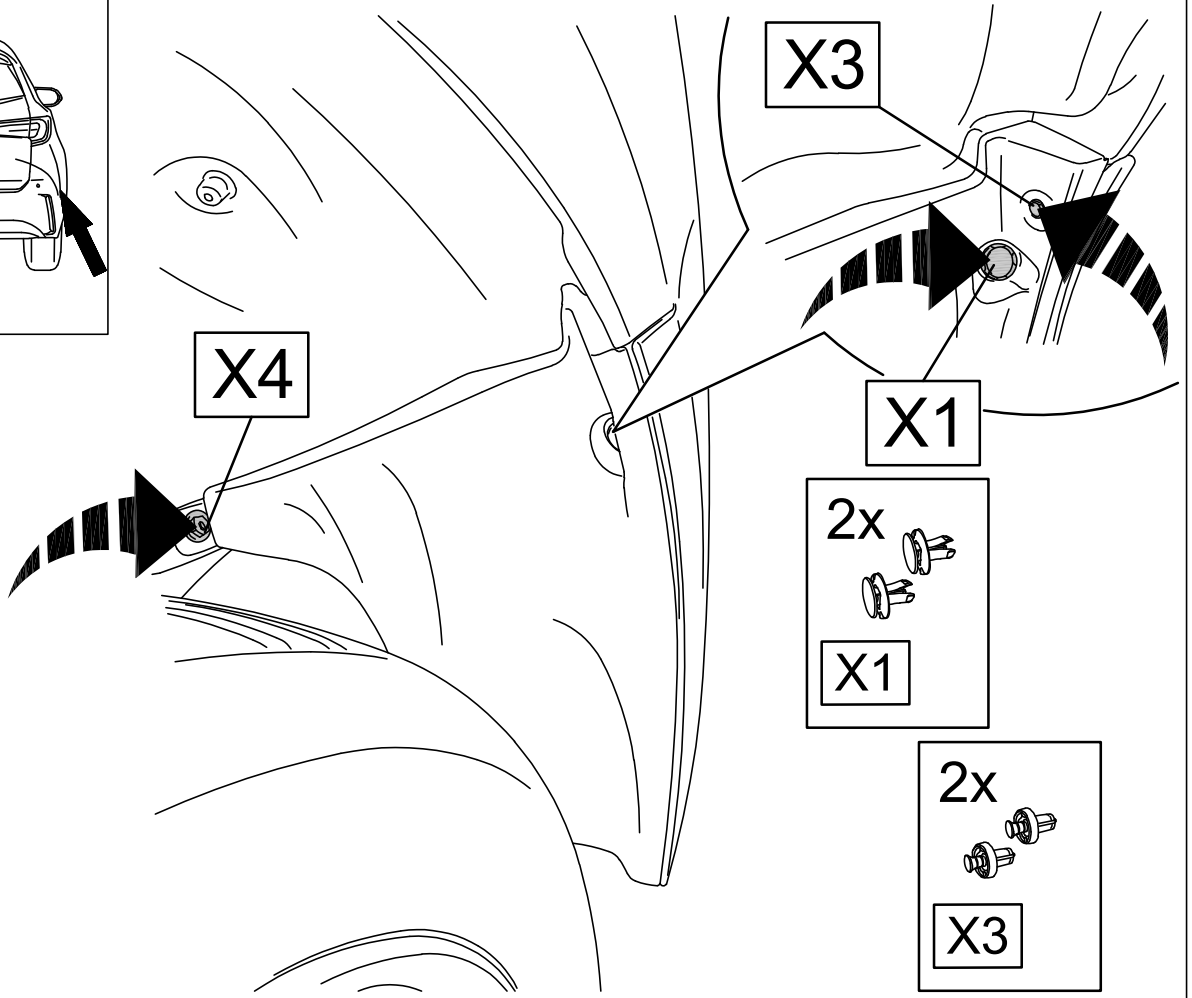
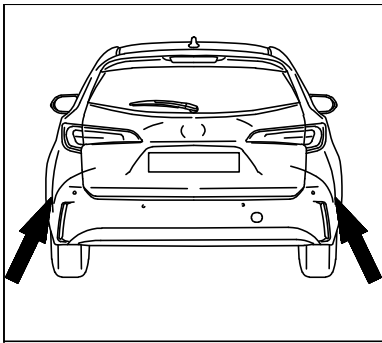

30

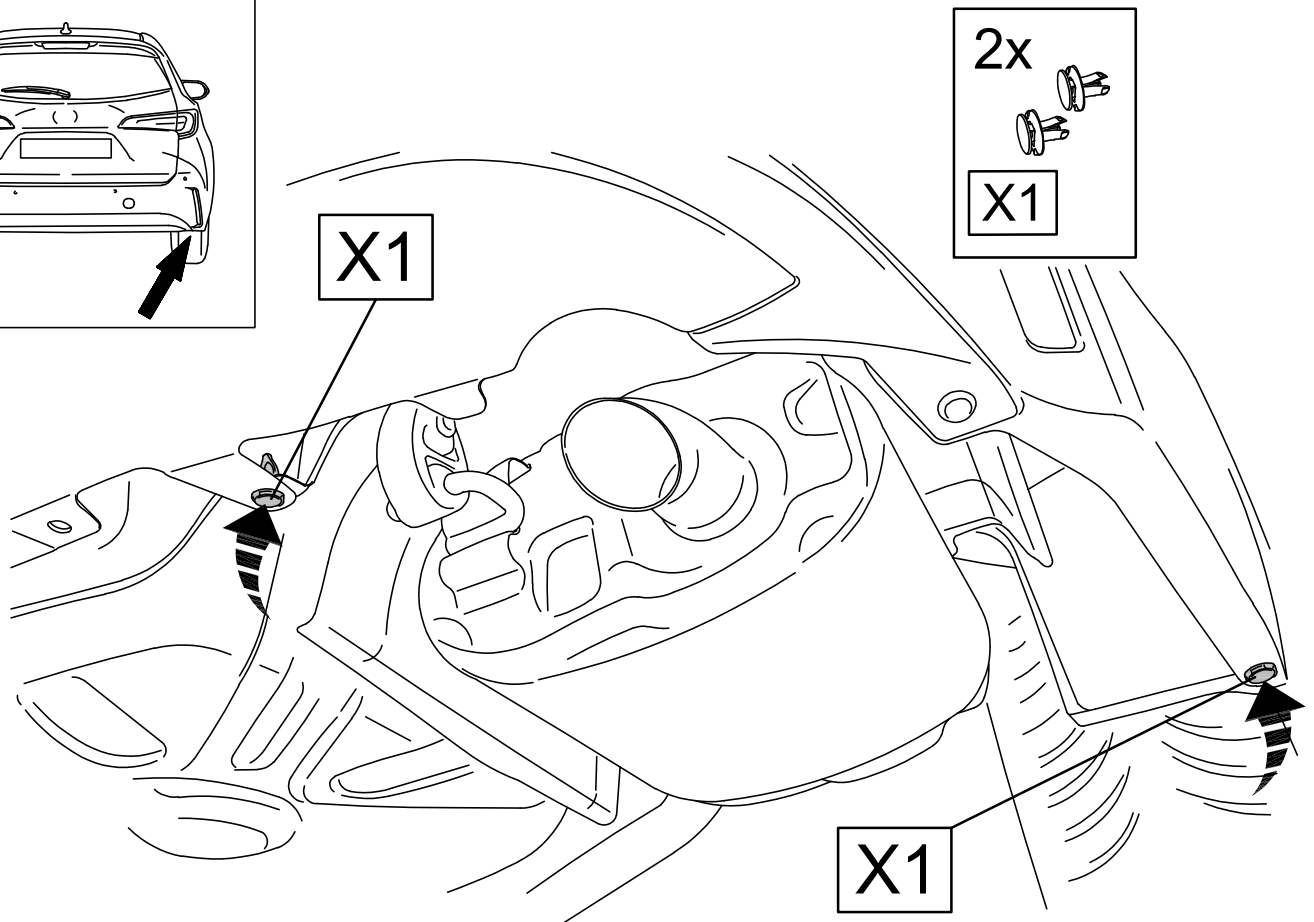
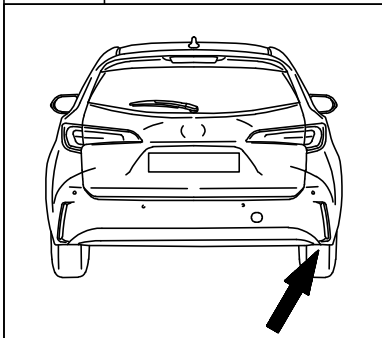

31

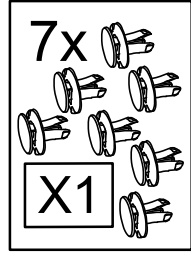
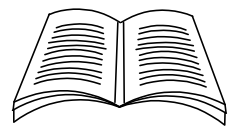
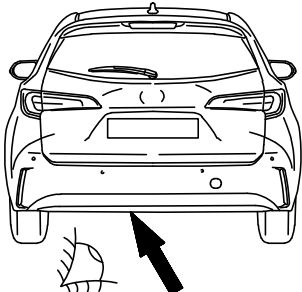

X1

X1

X2

32

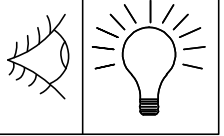

Zulässige Stützlast maximal 75 kg



22

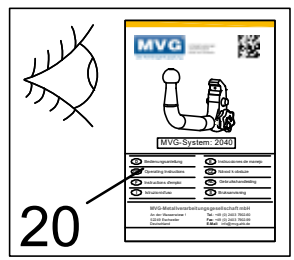
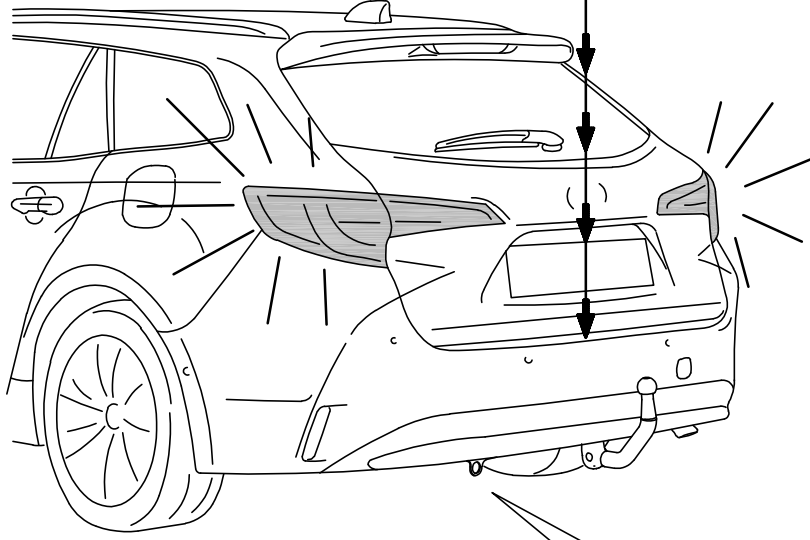

20

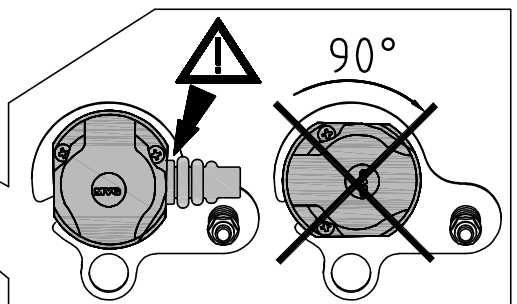

33

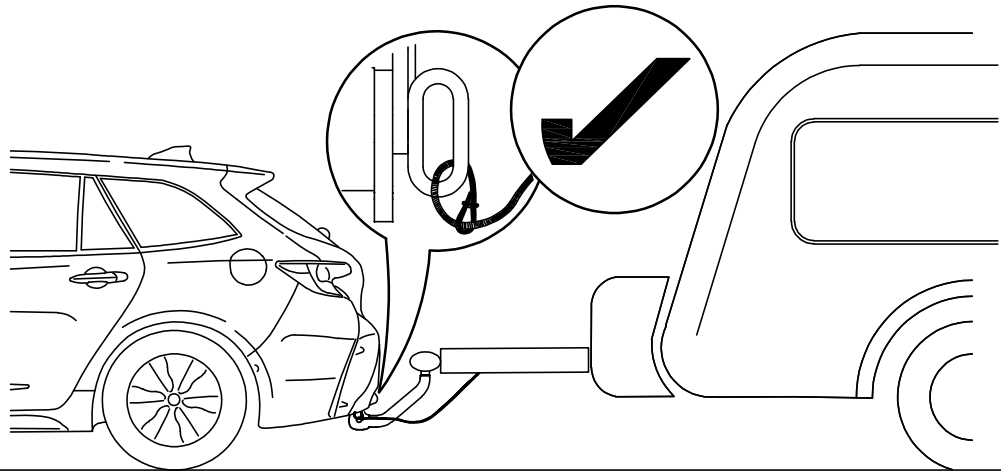
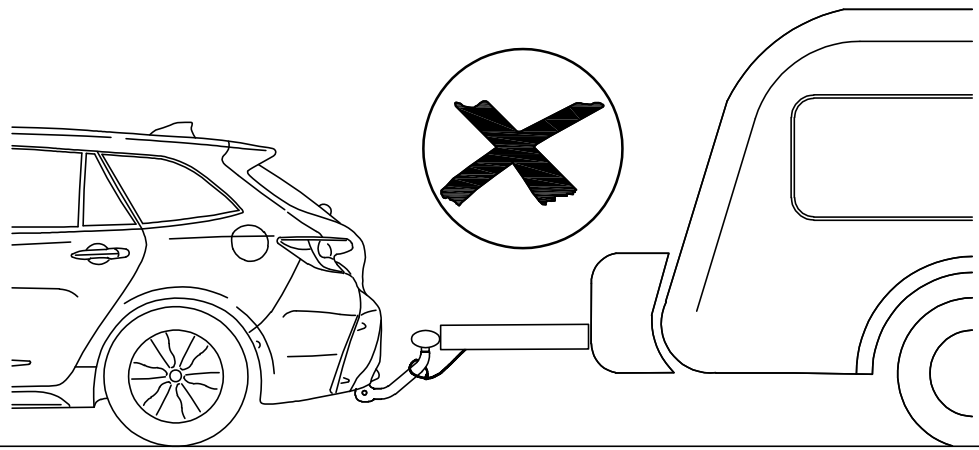

34

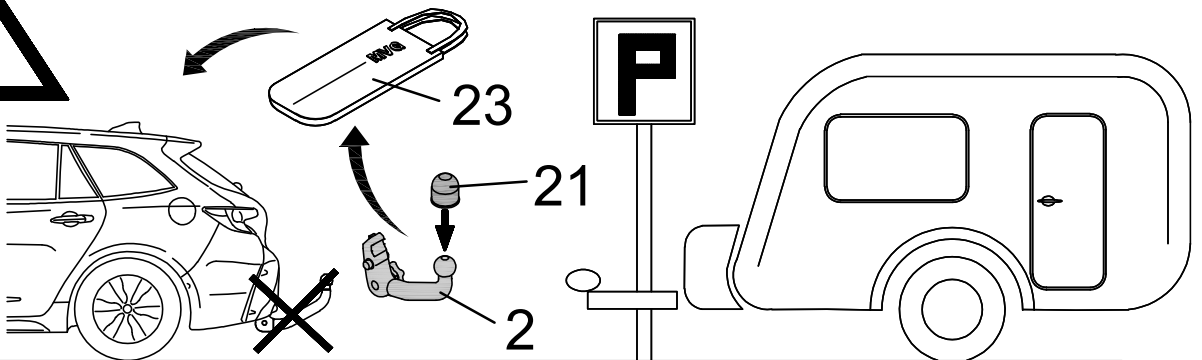
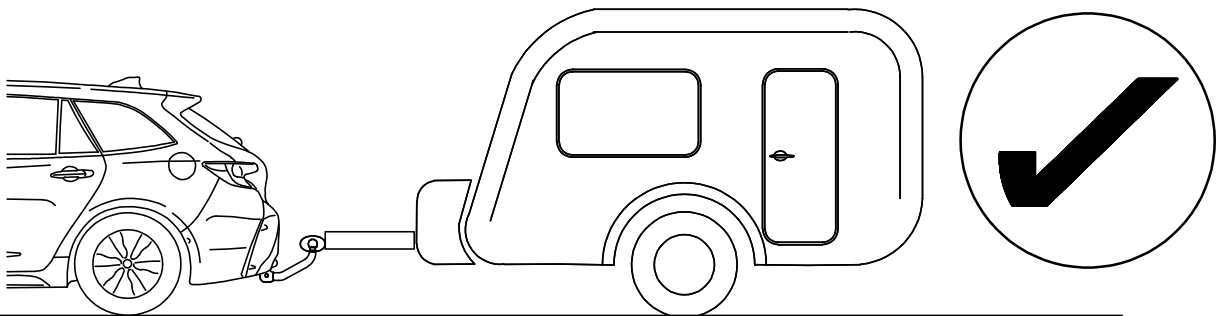

35

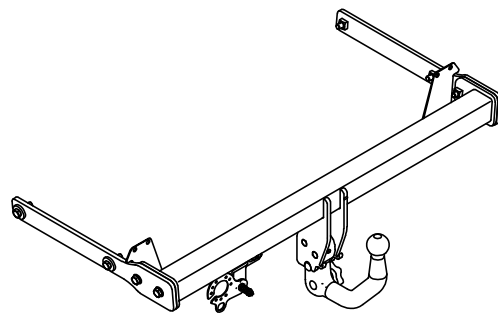
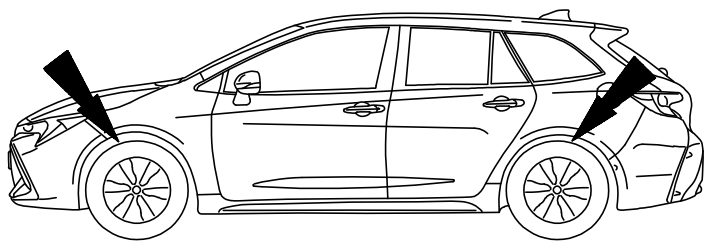

Best. Nr.: 3670 A

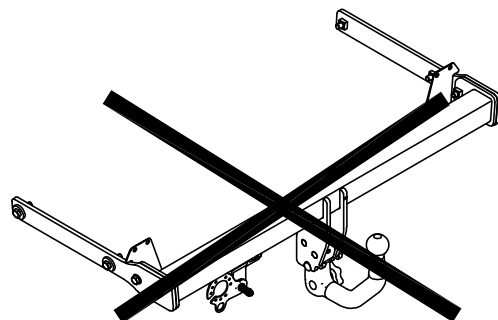
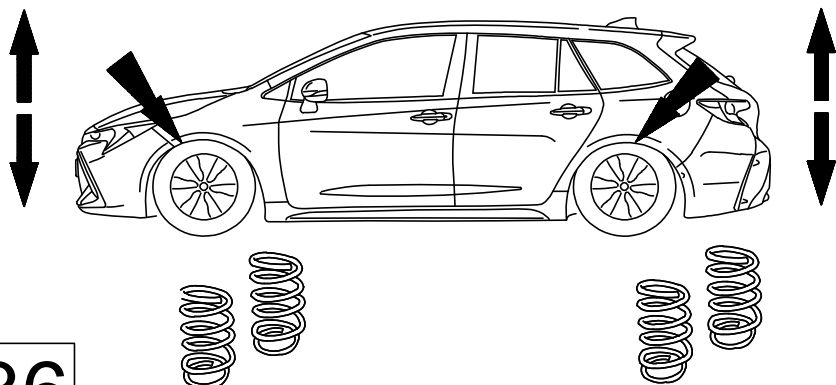

36

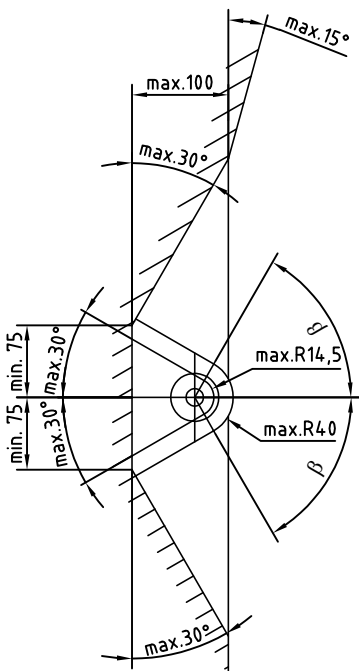
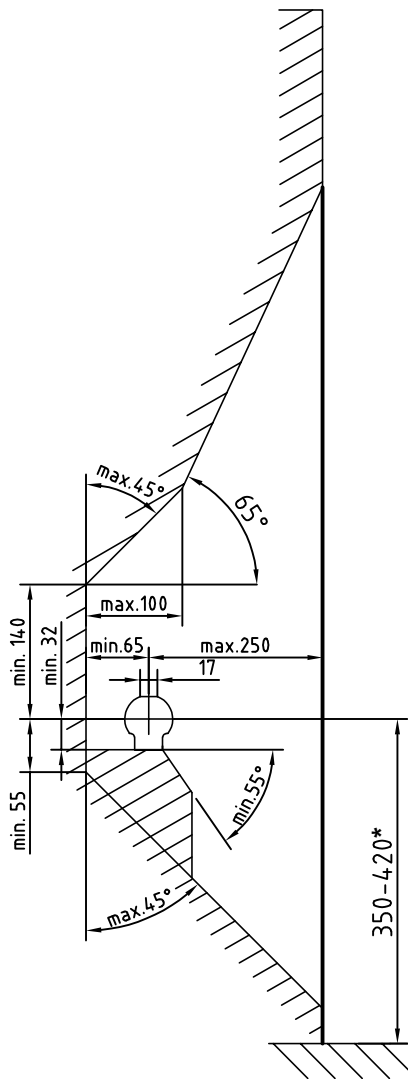

- D** Der Freiraum nach Anhang 7, Abbildung 25a und 25b der Richtlinie ECE-R 55 ist zu gewährleisten.
- CZ** Volný prostor ve smyslu Přílohy 7, obr. 25a a 25b směrnice ECE-R 55 musí být zaručen.
- DK** Det skal sikres, at der er spillerum i overensstemmelse med bilag 7, fig. 25a og 25b i henhold til direktiv ECE-R 55.
- E** Hay que garantizar el espacio libre conforme al anexo 7, fig. 25a y 25b de la directiva ECE-R 55.
- F** La zone de dégagement, selon l'annexe 7, figure 25a et 25b de la directive ECE-R 55, doit être assurée.
- FIN** Välyksen tulee täyttää ohjeen ECE-R 55 liitteen 7 kuvissa 25a ja 25b ilmoitetut vaatimukset.
- GB** Make sure to provide clearance according to appendix 7, figures 25a and 25b of the ECE-R 55 regulations.
- GR** Πρέπει να εξασφαλίζεται ο ελεύθερος χώρος σύμφωνα με το παράρτημα 7, σχήμα 25a και 25b της κοινοτικής οδηγίας ECE-R 55.
- H** Biztosítani kell az ECE-R 55 irányelv szerinti, 7. számú függelék, 25a. és 25b ábrákban jelölt szabad teret.
- I** Deve essere garantito lo spazio libero secondo l'allegato 7, figure 25a e 25b della normativa europea ECE-R 55.
- N** Det må sørges for fritt rom i samsvar med tillegg 7, figur 25a og 25b i direktiv ECE-R 55.
- NL** De vrije ruimte volgens supplement 7, afbeelding 25a en 25b van richtlijn ECE-R 55 moet gewaarborgd zijn.
- PL** Należy zapewnić wolną przestrzeń zgodnie z załącznikiem 7, rys. 25a i 25b, dyrektywy ECE-R 55.
- RUS** Оставлять свободное пространство согласно Приложению 7, рис. 25a и 25b Директивы ECE-R 55.
- S** Spelrummet enligt bilaga 7, bild 25a och 25b i riktlinje ECE-R 55, måste garanteras.

- D** * bei zulässigem Gesamtgewicht des Fahrzeuges
- CZ** * při celkové přípustné hmotnosti vozidla
- DK** * ved tilladt totalvægt for køretøjet
- E** * con peso total autorizado del vehículo
- F** * pour poids total en charge autorisé du véhicule
- FIN** * Ajoneuvon suurimmalla sallitulla kokonaispainolla
- GB** * at gross vehicle weight rating
- GR** * για το επιτρεπτό μικτό βάρος του οχήματος
- H** * A jármű megengedett összsúlya esetén
- I** * per il peso complessivo ammesso del veicolo
- N** * ved kjøretøyets tillatte totalvekt
- NL** * bij toegestaan totaal gewicht van het voertuig
- PL** * przy dopuszczalnym ciężarze całkowitym pojazdu
- RUS** * при допустимом общем весе автомобиля
- S** * vid fordonets tillåtna totalvikt

- D** Die Anhängervorrichtung ist ein Sicherheitsteil und darf nur von Fachunternehmen montiert werden. Bei falscher Montage besteht schwere Unfallgefahr! Der deutsche Text dieser Anleitung ist bindend.
- CZ** Tažné zařízení je bezpečnostní součást, kterou smí montovat pouze odborné podniky. Při chybné montáži hrozí vážné nebezpečí nehody! Německý text tohoto návodu je závazný.
- DK** Anhængertrækket er en sikkerhedsdel og må kun monteres af autoriserede firmaer. Ved forkert montering er der fare for alvorlige uheld! Den tyske tekst i denne vejledning er bindende.
- E** La bola de engancho es un elemento de seguridad y sólo se debe permitir su montaje a personal cualificado. ¡En caso de montaje erróneo existe peligro de accidentes graves! Es vinculante el texto alemán de estas instrucciones.
- F** Le dispositif d'attelage est un équipement de sécurité et doit être mis en place exclusivement par un atelier spécialisé. Un montage incorrect représente un risque élevé d'accident! Le texte allemand de cette notice fait foi.
- FIN** Vetolaite on turvallisuuteen vaikuttava osa, jonka saa asentaa vain alan erikoisliike. Virheellinen asennus voi aiheuttaa vakavan onnettomuuden! Tämän ohjeen saksankielinen teksti on sitova.
- GB** A trailer hitch is a safety-critical part and may be fitted only by qualified companies. Improper assembly may result in a serious accident hazard! The German text of this instruction is binding.
- GR** Ο κοτσαδόρος είναι ένα εξάρτημα ασφαλείας και η τοποθέτηση του επιτρέπεται να γίνεται μόνο από εξειδικευμένο συνεργείο. Σε περίπτωση λάθους τοποθέτησης υπάρχει κίνδυνος σοβαρών ατυχημάτων! Το γερμανικό κείμενο αυτών των οδηγιών είναι δεσμευτικό.
- H** A vonószerkezet egy biztonsági felszerelés, amelyet csak szaküzem szerelhet fel. Helytelen szerelés súlyos balesethez vezethet! A német szerelési utasítás betartása kötelező.
- I** Il gancio di traino è un componente di sicurezza e deve essere montato esclusivamente da personale specializzato. In caso di montaggio errato sussiste il pericolo di incidenti gravi! È vincolante il testo tedesco di queste istruzioni.
- N** Tilhengerfestet er en sikkerhetskompoment og skal monteres av fagbedrift. Det er stor fare for at det kan oppstå ulykker ved feil montering! Den tyske teksten i denne veiledningen er bindende.
- NL** De aanhanger is veiligheidsonderdeel en mag alleen door vakkundig personeel worden gemonteerd. Bij verkeerde montage bestaat ernstig gevaar voor ongevallen! De Duitse tekst van deze handleiding is bindend.
- PL** Hak holowniczy stanowi element bezpieczeństwa i może zostać zamontowany wyłącznie przez firmę specjalistyczną. W przypadku nieprawidłowego montażu istnieje poważne ryzyko wypadku! Tekst niniejszej instrukcji w języku niemieckim jest wiążący.
- RUS** Сцепное устройство - это узел, несущий предохранительные функции, и к его монтажу допускаются только специалисты. При неправильном монтаже грозит опасность тяжелых травм! Обязательным является немецкий текст данной инструкции.
- S** Dragkroken är en säkerhetskompoment och bör endast monteras av kvalificerade tekniker. Vid felaktig montering föreligger risk för allvariga olyckor! Den tyska texten i denna anvisning är bindande.

Dispositivo di traino tipo:

3670 A

Per autoveicoli:

Toyota Corolla Touring Sports (Hybrid) / Suzuki Swace

Tipo funzionale:

2020 -->

Classe e tipo di attacco:

CLASS A50-X

Omologazione:

E4 55R-02 1197

Valore D:

8,6 kN

Carico verticale max. S:

90 kg

Larghezza rimorchiabile per Caravan e T.A. T.S.: 2,45 m vedere CARTA di CIRCOLAZIONE VEICOLO (motrice) + 70 cm = arrotondare ai 5 cm superiore (vedi D.M. 28/05/85)

Massa rimorchiabile:

Vedi carta circolazione dell' autoveicolo

$$D = ((T \times C) / (T+C)) \times 0,00981 = 8,6 \text{ kN} < D$$

Per verificare l'idoneità del dispositivo di traino omologato a norma ECE-R55, all'installazione sulla vettura su cui si intende procedere al montaggio, compilare la seguente formula (se necessario declassare la massa rimorchiabile):

dove: T = Massa Complessiva Max. della motrice (in kg)
C = Massa Rimorchiabile Max. della motrice (in kg)

DA COMPILARE PER IL COLLAUDO

DICHIARAZIONE DI CORRETTO MONTAGGIO: la sottoscritta Ditta dichiara di aver montato in maniera corretta ed in conformità alle prescrizioni sia del costruttore del veicolo che del costruttore del dispositivo stesso il seguente dispositivo di attacco meccanico:

Tipo:

Il dispositivo di attacco sopra indicato è stato installato su autoveicolo

Modello:

Targa:

Data:

TIMBRO e FIRMA

Si dichiara inoltre di aver informato l'utente del veicolo sull'USO e MANUTENZIONE del dispositivo stesso.

Die Bedienungsanleitung als Video finden Sie unter folgendem Link:

This instruction manual can be found as an illustrating video under the following link:

<https://mvg.li/2040>

Außerdem können Sie mit Ihrem Smartphone den Video-Link durch diesen QR-Code direkt scannen und das Video ansehen.

Furthermore, the link to the video can be scanned and watched via this QR code by the use of your smartphone.



www.mvg-ahk.de
www.mvg-ahk.at
www.mvg-ahk.ch
www.mvg-ahk.com