

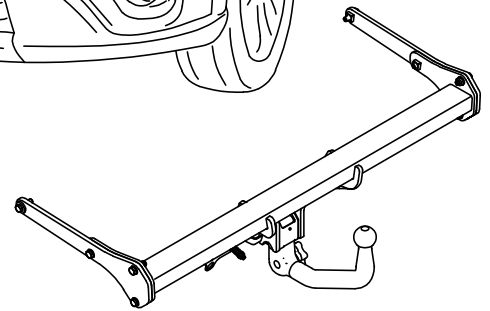

Die Anhängerkupplung.

Anhängerkupplungen  
und Elektrosätze  
direkt vom Hersteller

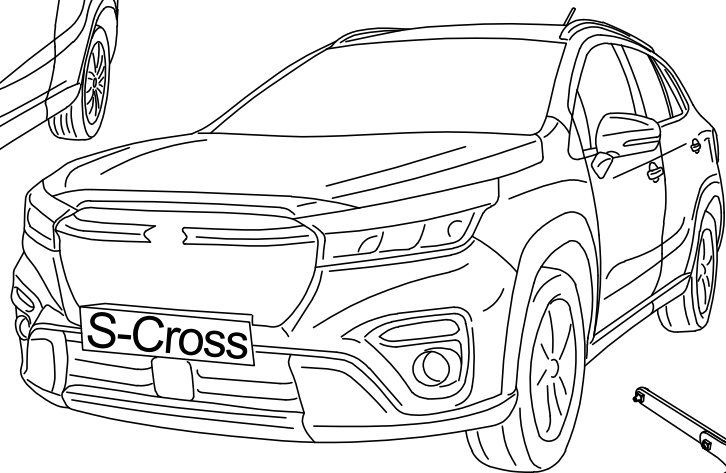
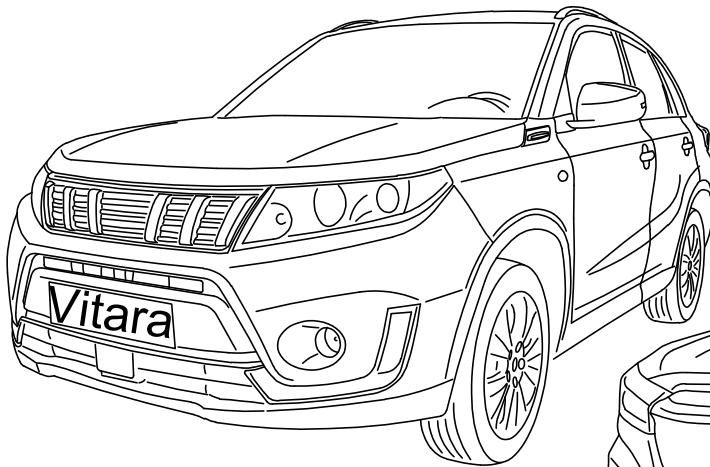

MVG: 3521 A

Suzuki Vitara 10/2018→

Suzuki S-Cross 01/2022→

**D** Einbauanleitung

**GB** Installation instruction

**F** Notice de montage

**I** Istruzioni di montaggio

**E** Instrucciones de montaje

**CZ** Návod k montáži

**NL** Inbouw instructie

**S** Monteringsanvisning

## MVG-Metallverarbeitungsgesellschaft mbH

An der Wasserwiese 1  
52249 Eschweiler  
Deutschland

**Tel.:** +49 (0) 2403 7902-60  
**Fax:** +49 (0) 2403 7902-99  
**E-Mail:** [info@mvg-ahk.de](mailto:info@mvg-ahk.de)

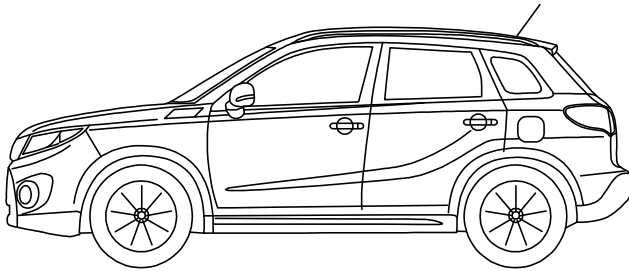
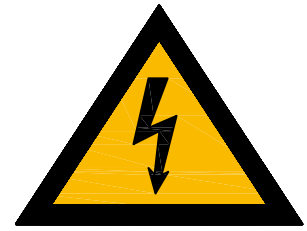

SUZUKI Vitara  
(HYBRID)

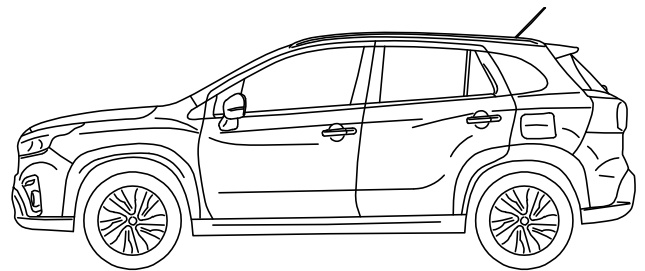

SUZUKI S-Cross  
(HYBRID)

## **Achtung!**

Bei diesem Fahrzeugmodell handelt es sich um ein Fahrzeug mit gefährlicher Hochspannung. Bei unsachgemäßer Handhabung kann es durch Stromschlag oder Kurzschluss zu lebensgefährlichen Auswirkungen kommen. Achten Sie auf die ausreichende Qualifikation des Mitarbeiters bei Arbeiten an Fahrzeugen mit Hochvolt-System. Lesen Sie die Warn- und Sicherheitshinweise im Werkstattinformationssystem. Führen Sie ausschließlich die in dieser Anleitung beschriebenen Arbeitsschritte durch. Trennen Sie keine orangefarbenden Kabel. Achten Sie auf Warnsymbole wie einen Hochvoltblitz!



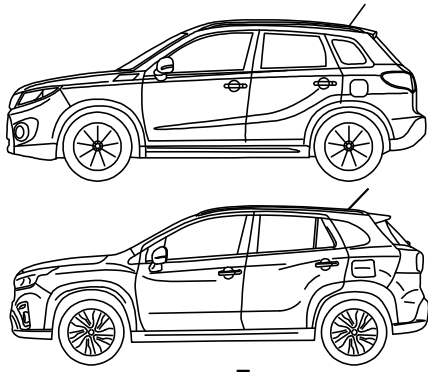

↓ ≤ 1780 kg

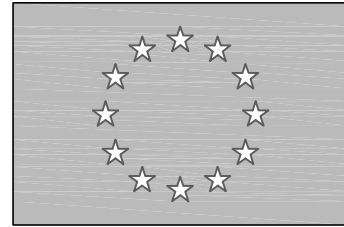

**EG**

Vitara: e4 \* 2007/46 \* 0928  
S-Cross: e4 \* 2007/46 \* 0779

$$D = 8,5 \text{ kN}$$

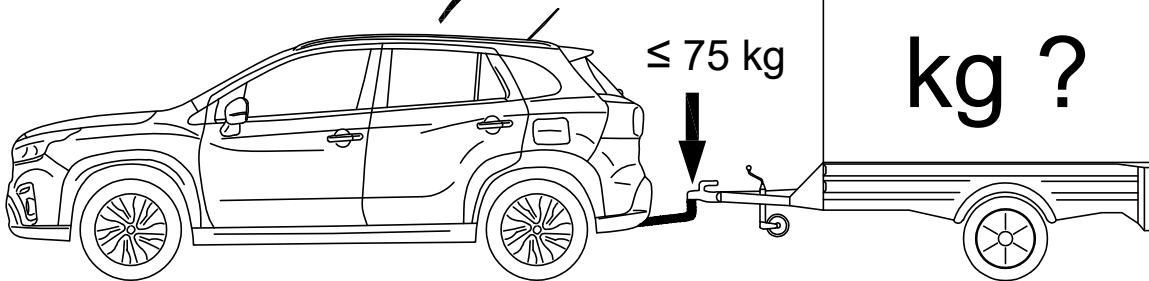
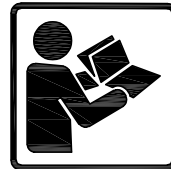

$$D = \frac{T \times R}{1000 \times (T + R)} \times g$$

$$g = 9,81 \text{ m/s}^2$$

$$T = \frac{R \times D \times 1000}{(g \times R) - (1000 \times D)}$$

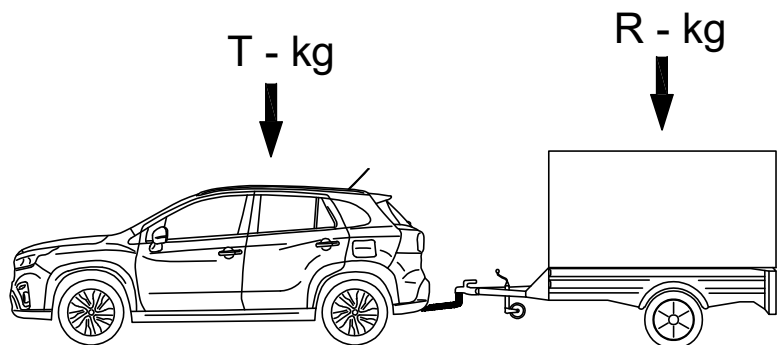

$$R = \frac{T \times D \times 1000}{(g \times T) - (1000 \times D)}$$

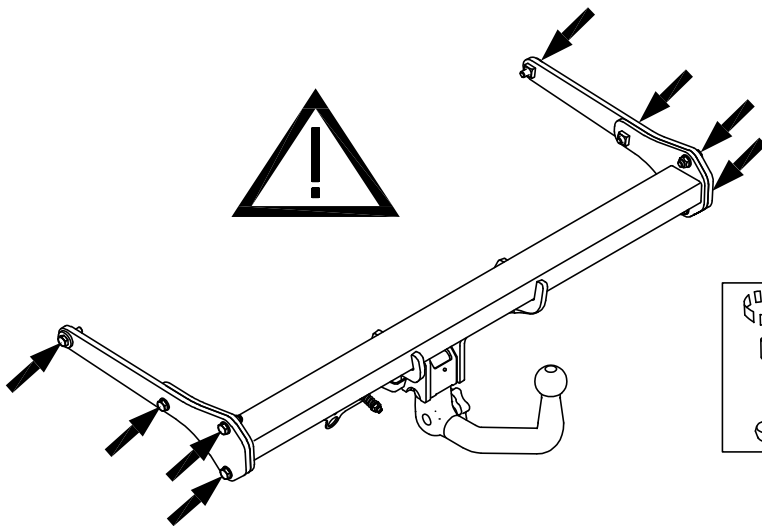
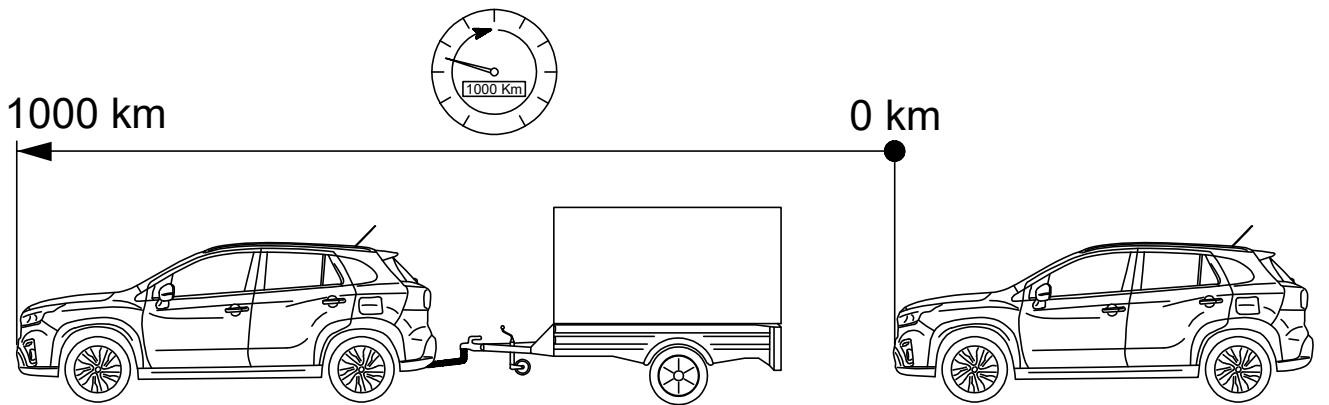
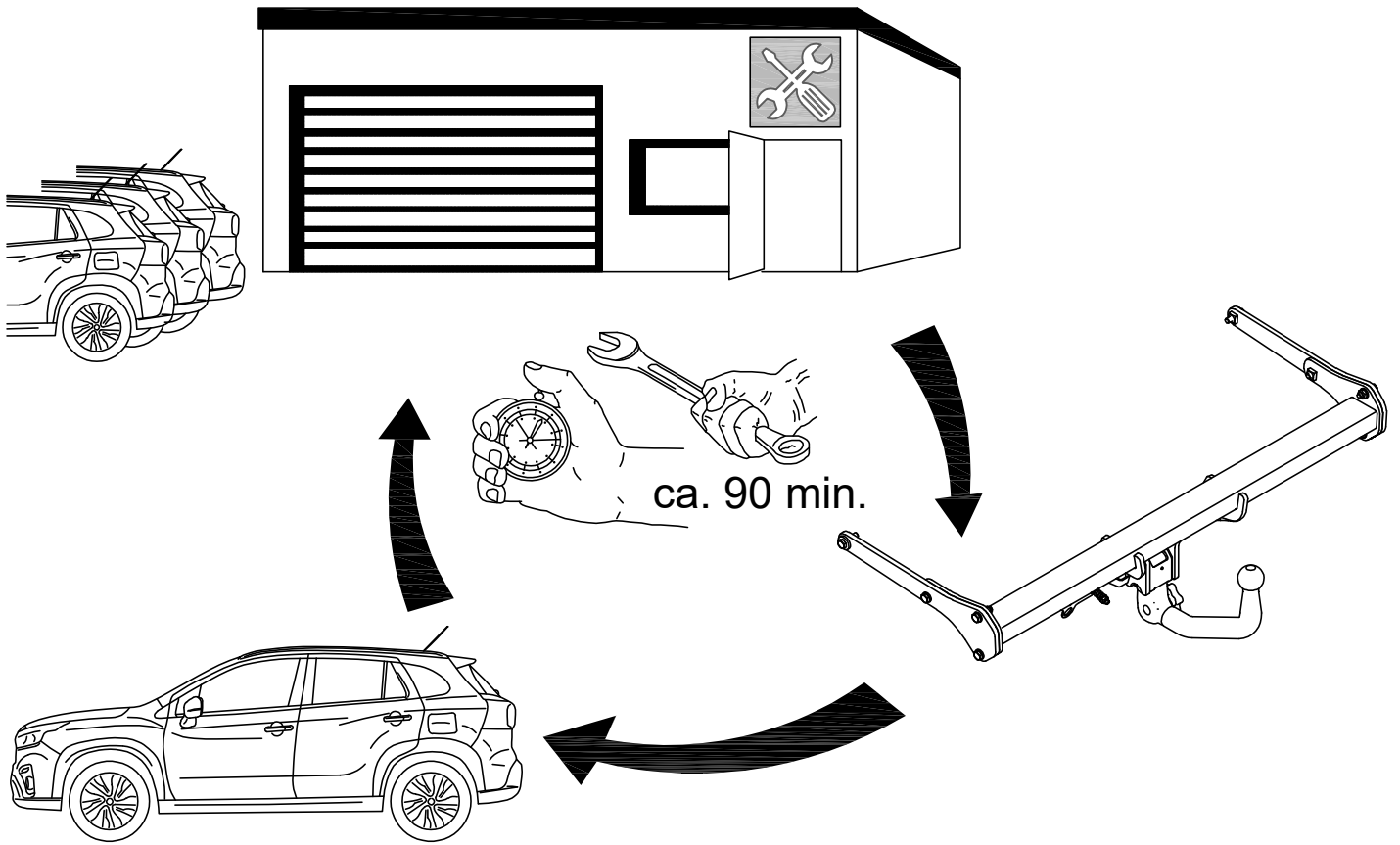

 <p>M10</p>	<p>60 Nm</p>
--	--------------

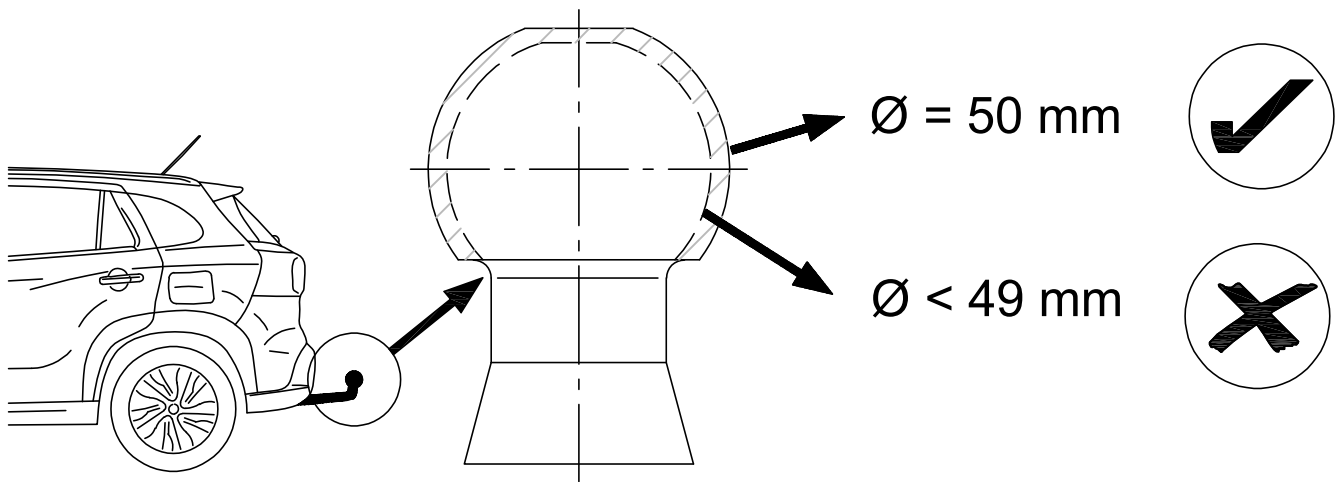

**MVG**<sup>®</sup> Approval Number  
 MVG-Metallverarbeitungsgesellschaft mbH **E4** 55R-01 1113  
 Type: 3521 A D-Value: 8,5 kN  
 Class: A50-X S-Value: 90 kg  
 Made in Germany [www.mvg-ahk.de](http://www.mvg-ahk.de)

Zulässige Stützlast  
 maximal 75 kg

**MVG**<sup>®</sup>  
 MVG-Metallverarbeitungsgesellschaft mbH  
[www.mvg-ahk.de](http://www.mvg-ahk.de)

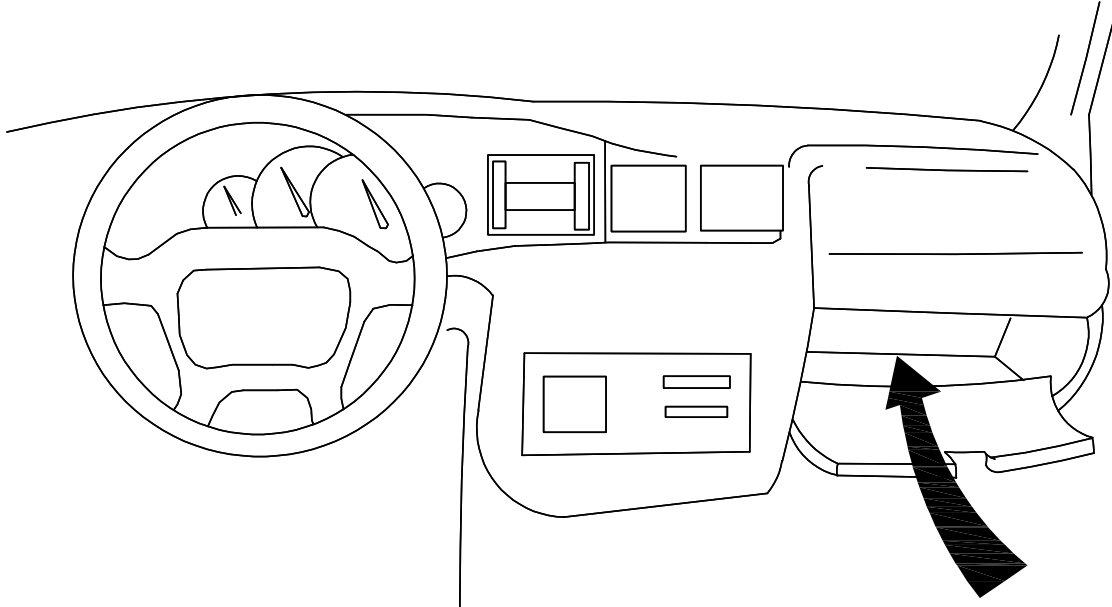

Technische Änderungen vorbehalten

**MVG**

MVG xxxxx A  
 Suzuki Vitara 1000i6-4  
 Suzuki SX4 S-Cross 100212

Installation	Montageanleitung
Technische Zeichnungen	Montage- & Ersatzteile
Notizen zu Montage	Service-Handbuch
Materialienliste	Wartungsanleitung

MVG-Metallverarbeitungsgesellschaft mbH  
 Am Alten Rasthaus 1 Tel: +49 (0) 2463 7932-0  
 52699 Solingen 1 Fax: +49 (0) 2463 7932-20  
 Deutschland E-Mail: [info@mvg-ahk.de](mailto:info@mvg-ahk.de)

**MVG**

MVG-System: 2040

Montageanleitung	Montageanleitung
Technische Zeichnungen	Montage- & Ersatzteile
Notizen zu Montage	Service-Handbuch
Materialienliste	Wartungsanleitung

MVG-Metallverarbeitungsgesellschaft mbH  
 Am Alten Rasthaus 1 Tel: +49 (0) 2463 7932-0  
 52699 Solingen 1 Fax: +49 (0) 2463 7932-20  
 Deutschland E-Mail: [info@mvg-ahk.de](mailto:info@mvg-ahk.de)

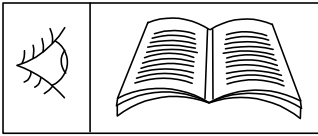

siehe Werkstatthandbuch

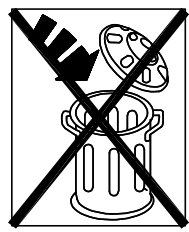

Nicht Entsorgen

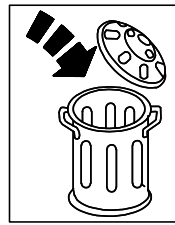

Entsorgen

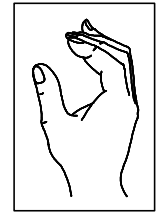

Von Hand



Achtung

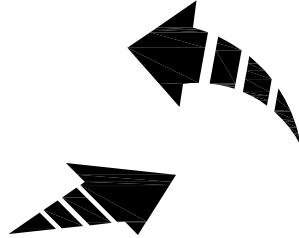

Bewegungspfeil



Positionspfeil

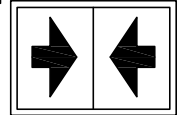
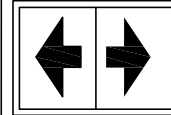

Stecker lösen/ verbinden



Achtung Hochvolt

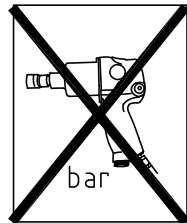

Ohne Druckluft

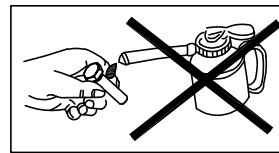

Nicht ölen

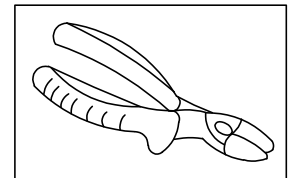

Seitenschneider verwenden

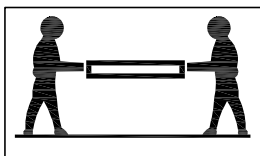

Nur zu zweit ausführen

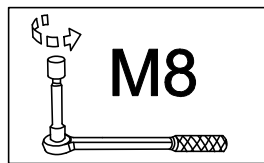

Festdrehen

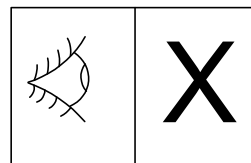

Siehe Abbildung

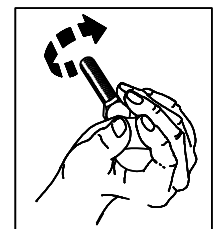

Von Hand festdrehen

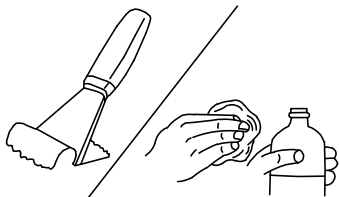

**CLEANER**  
Unterbodenschutz entfernen  
(Reinigen)



Gegen Korrosion schützen

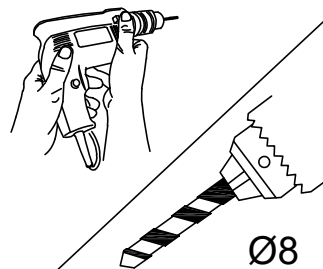

Bohrer verwenden



Kleben

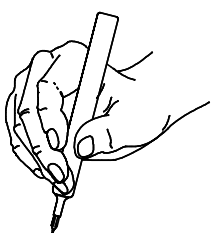

Anzeichnen

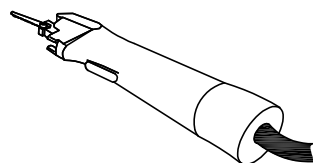



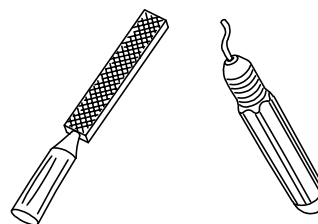



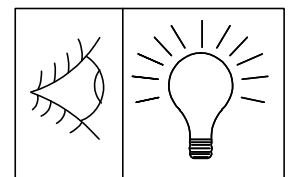





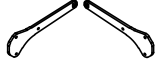









Schneiden



Feilen/ Entgraten

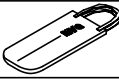

Licht kontrollieren

1	1x		3521 A	
2	1x		2040 A 017	
3	je 1		(links & rechts)	
4	8x		M10x35 (10.9)	ISO 4017
5	2x		Ø10,5/ 28x4	DIN 6340
6	10x		Ø10,5/ 20x2	ISO 7089
7	4x		M10 (10)	ISO 7042
8	1x			
9	1x		M8x45 (8.8)	ISO 4017
10	1x		Ø8,4/ 16x1,6	ISO 7089
11	1x			
12	1x			
13	2x		Ø8,4/16x1,6	DIN 125 PA 6.6
14	1x		M8 (8)	ISO 7042
15	1x		3521 A	
16	1x		System 2040	
17	1x			0062
18	1x		75 kg	1016
19	1x			1012
20	2x			
21	1x			0076
22	1x			0076
23	1x		PE Zuschnitt	

(D) Lieferumfang der Anhängervorrichtung

(GB) Scope of delivery of towing hitch

(F) Pièces comprises dans la fourniture de l'attelage

(I) Dotazione del gancio di traino

(E) Volumen de suministro del enganche

(CZ) Objem dodání tažného zařízení

(NL) Leveringsomvang trekhaak

(S) Dragkrokens leveransspecifikation





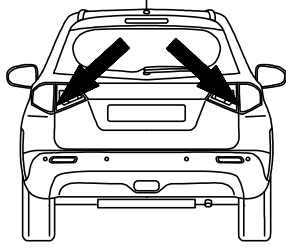

# Vitara

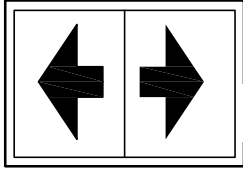

X2

X1

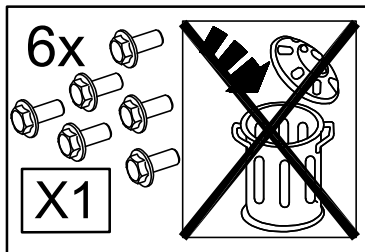

2

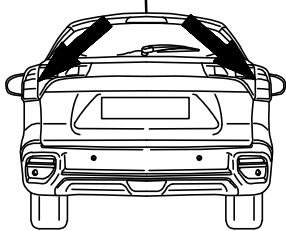

# S-Cross

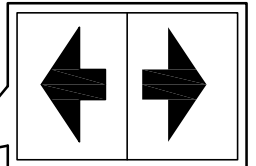

X1

X2

X1

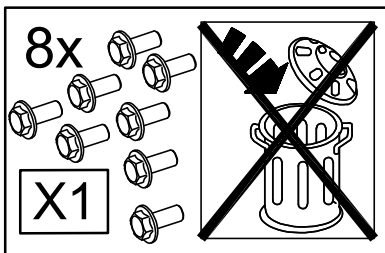

3

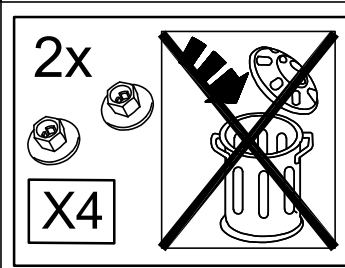
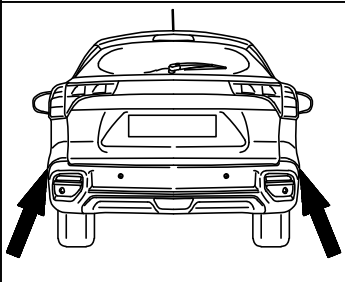
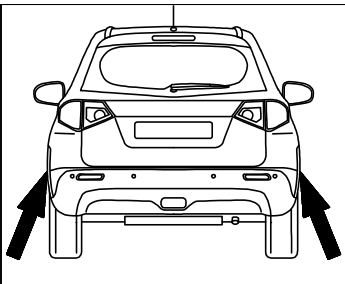

4

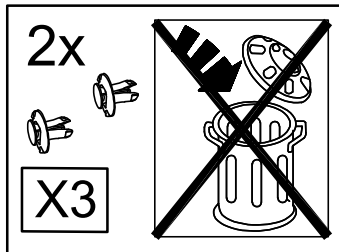

X4

X3

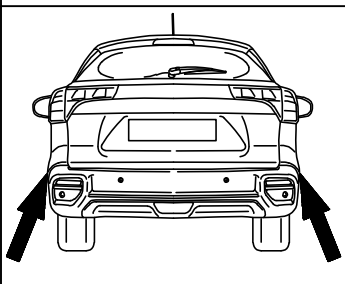
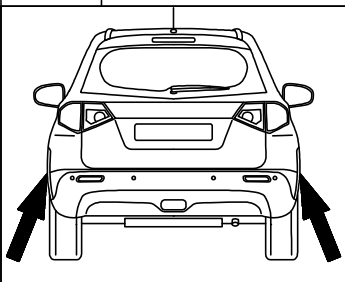
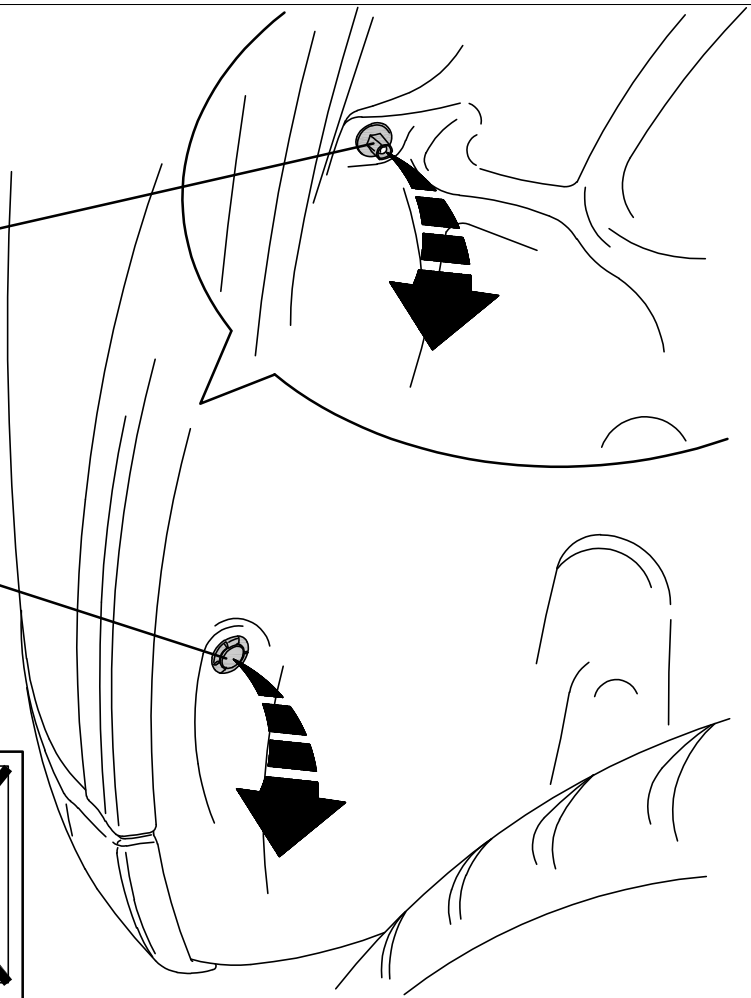

5

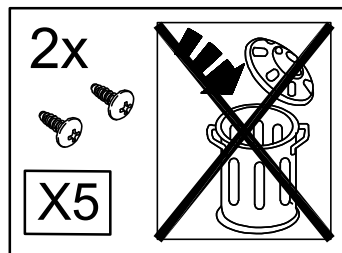
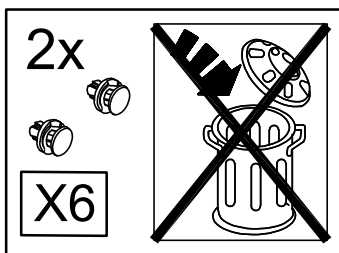

X6

X5

"STOP"

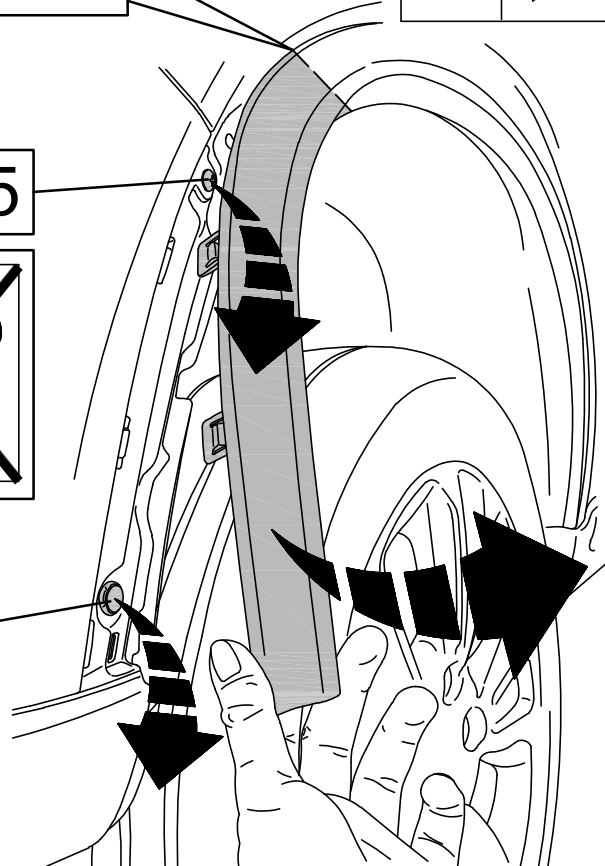
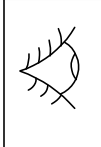

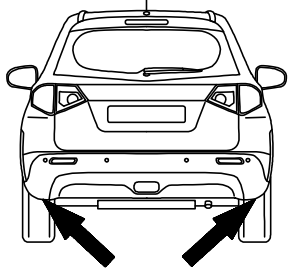

# Vitara

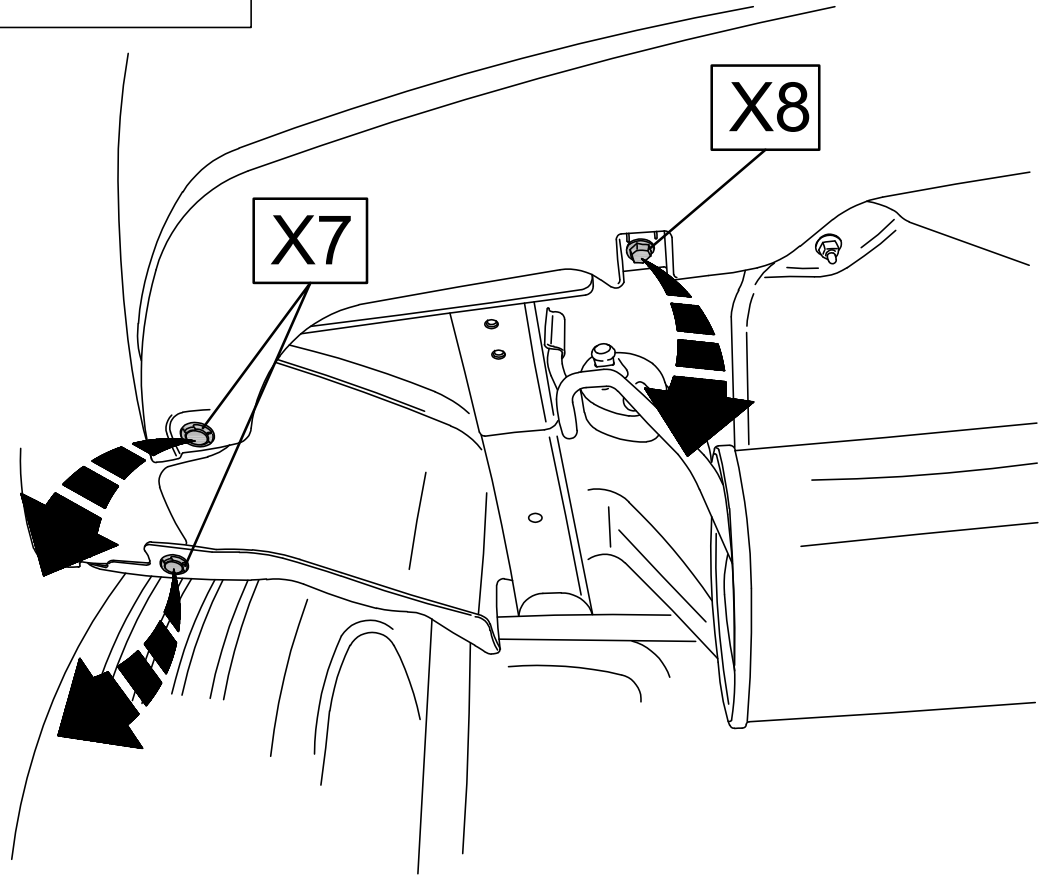
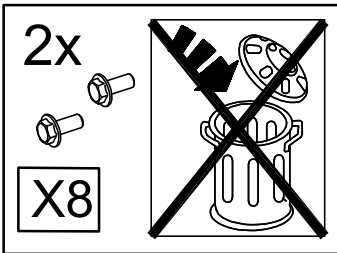
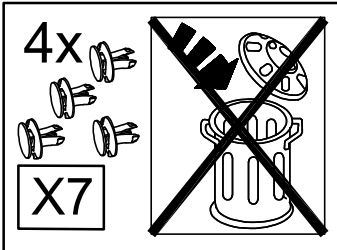

6

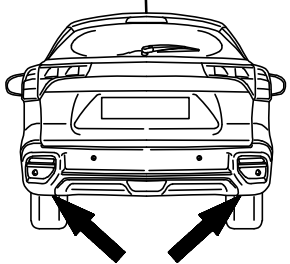

# S-Cross

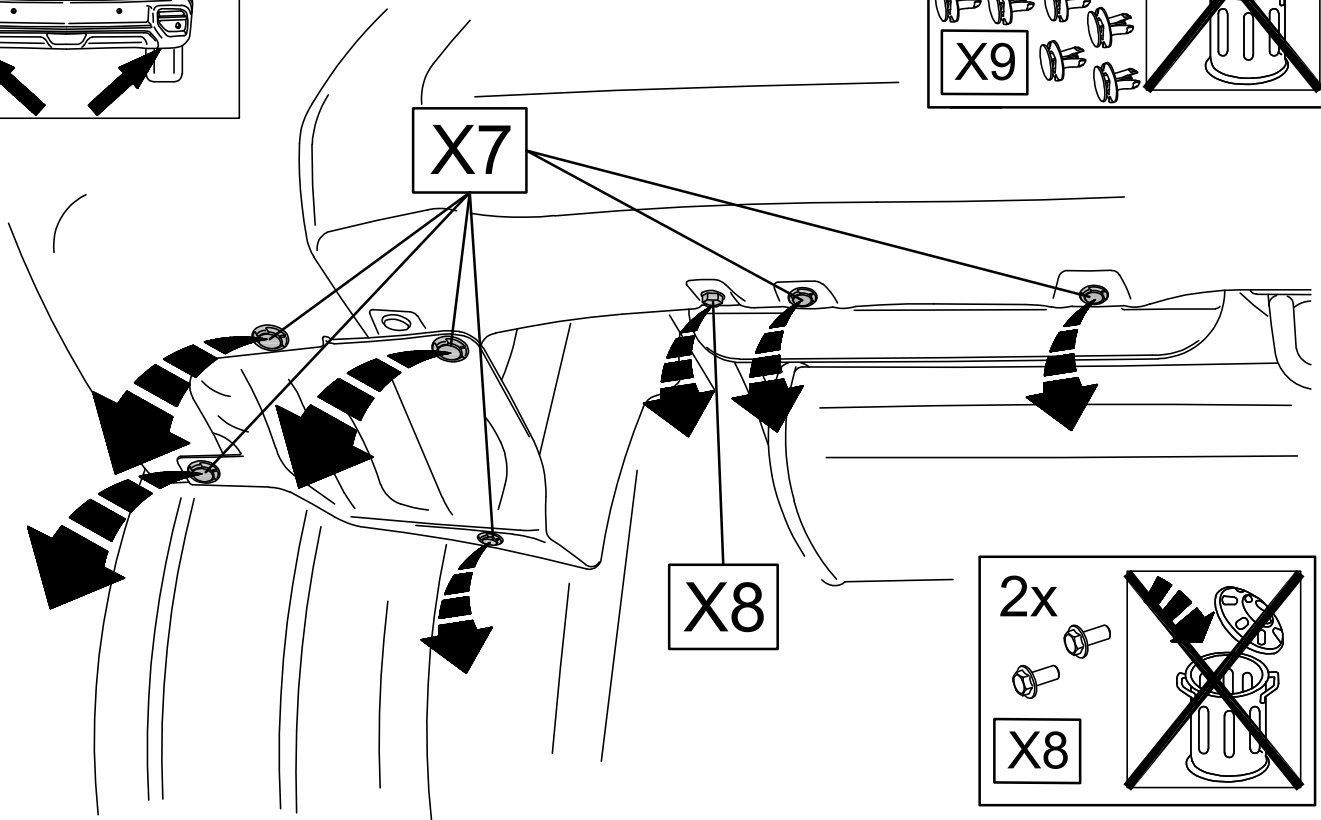
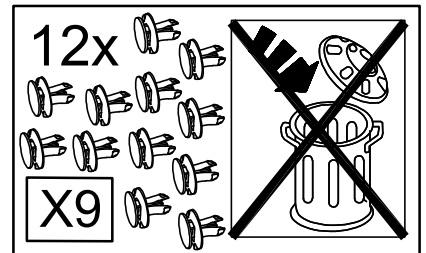

7

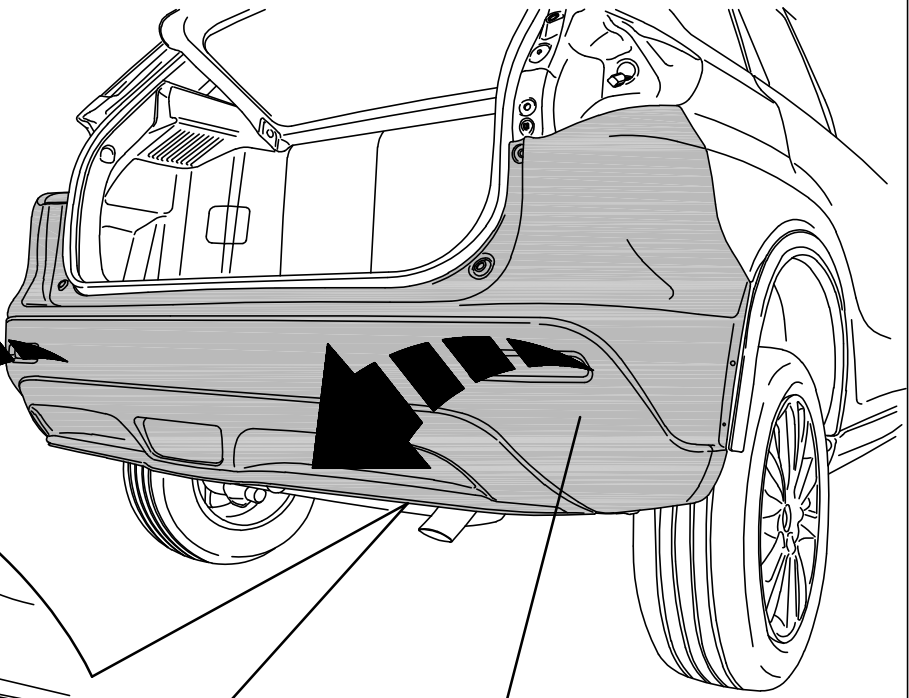
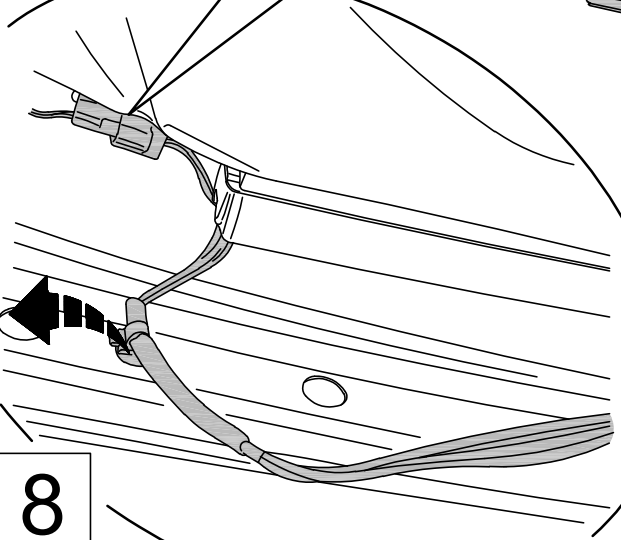
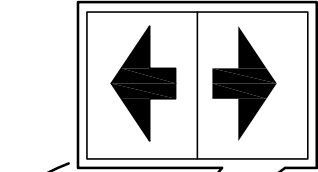
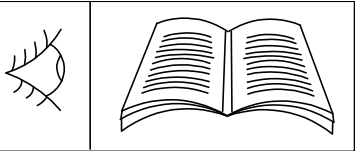

X9



8

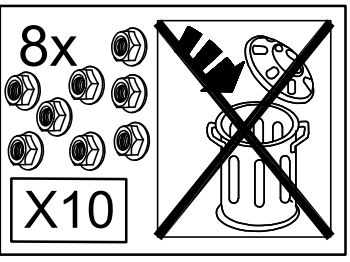
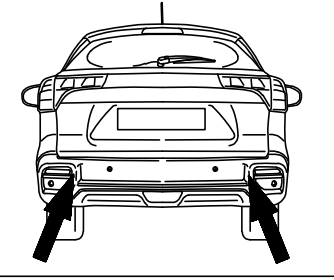
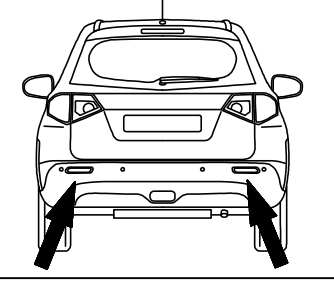

X10

X10

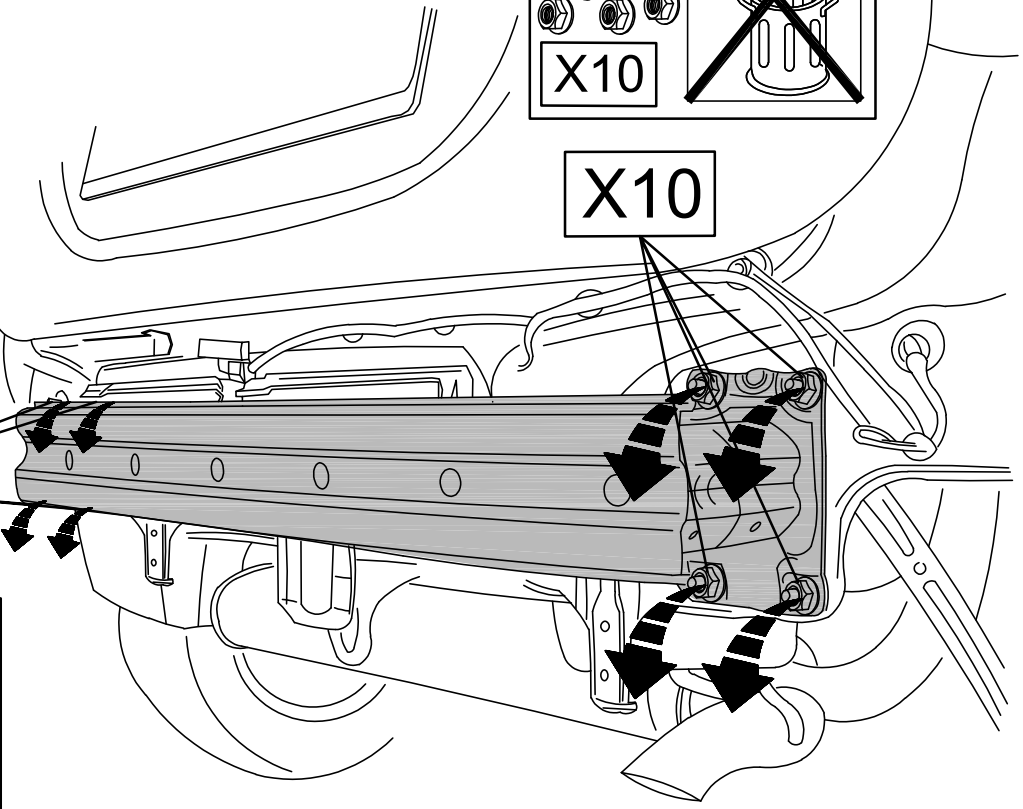

9

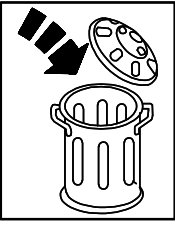

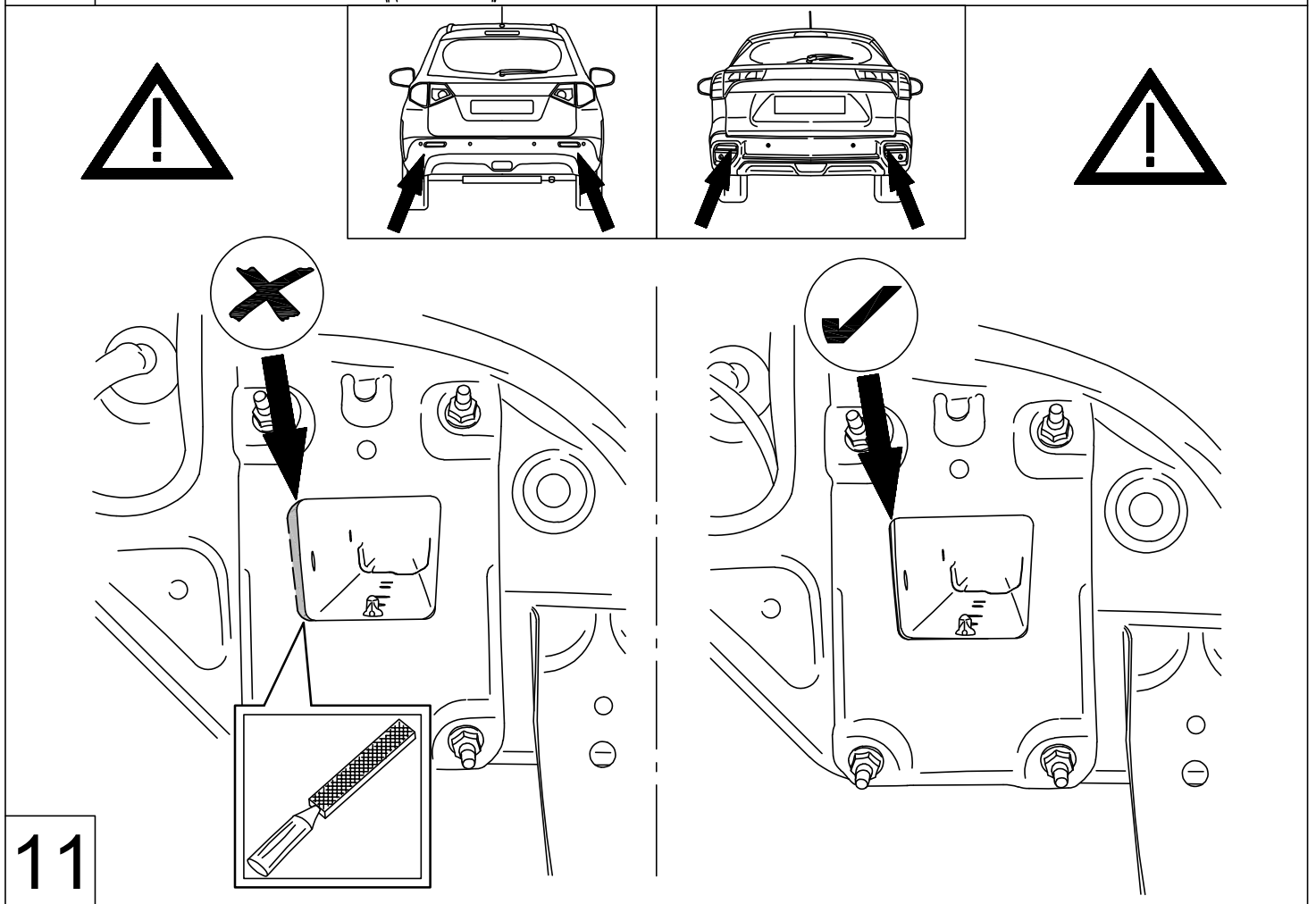
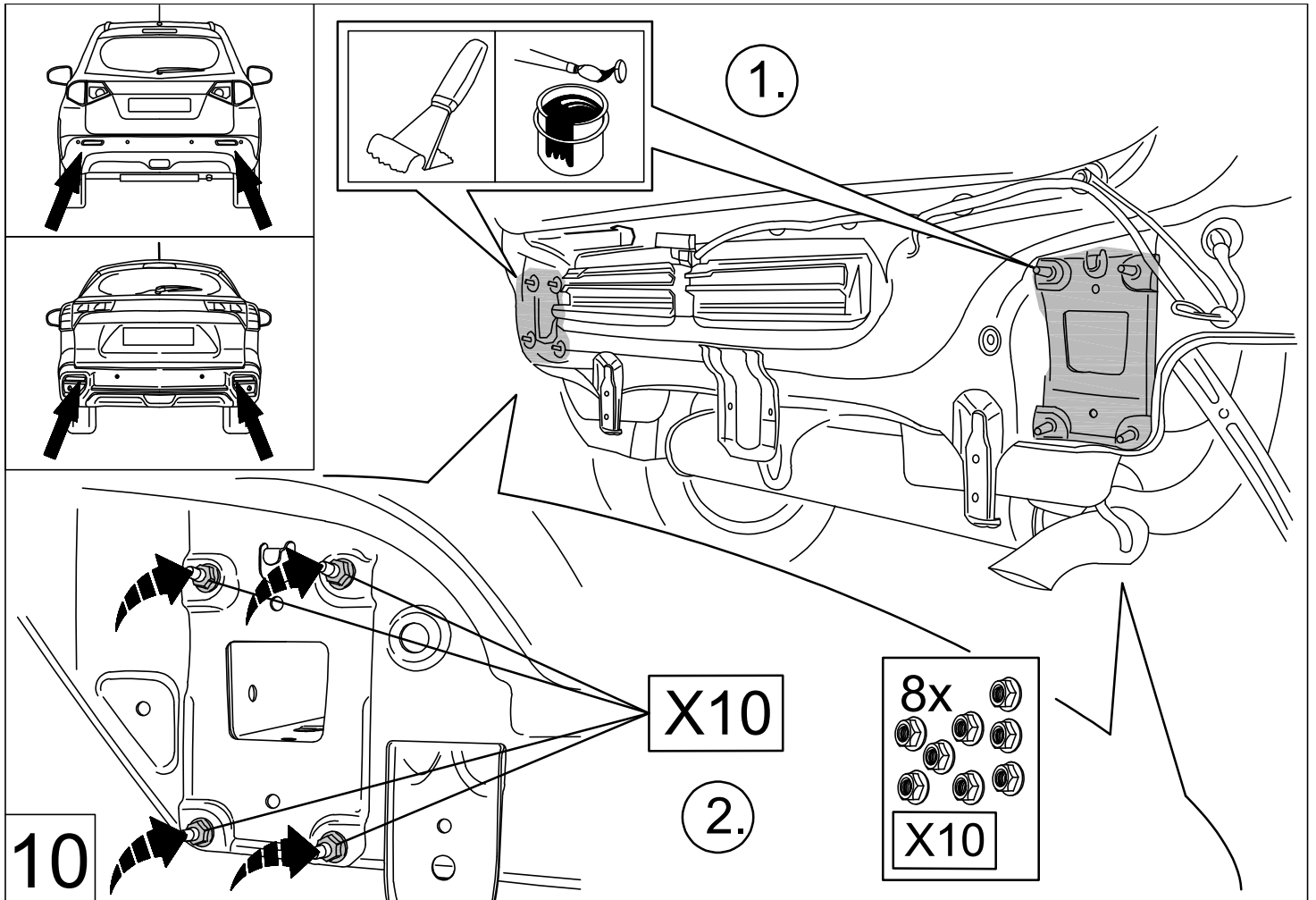

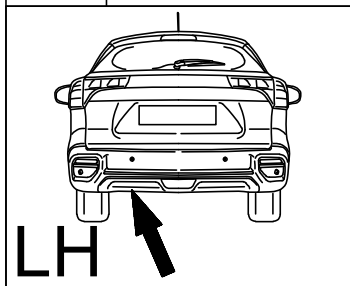
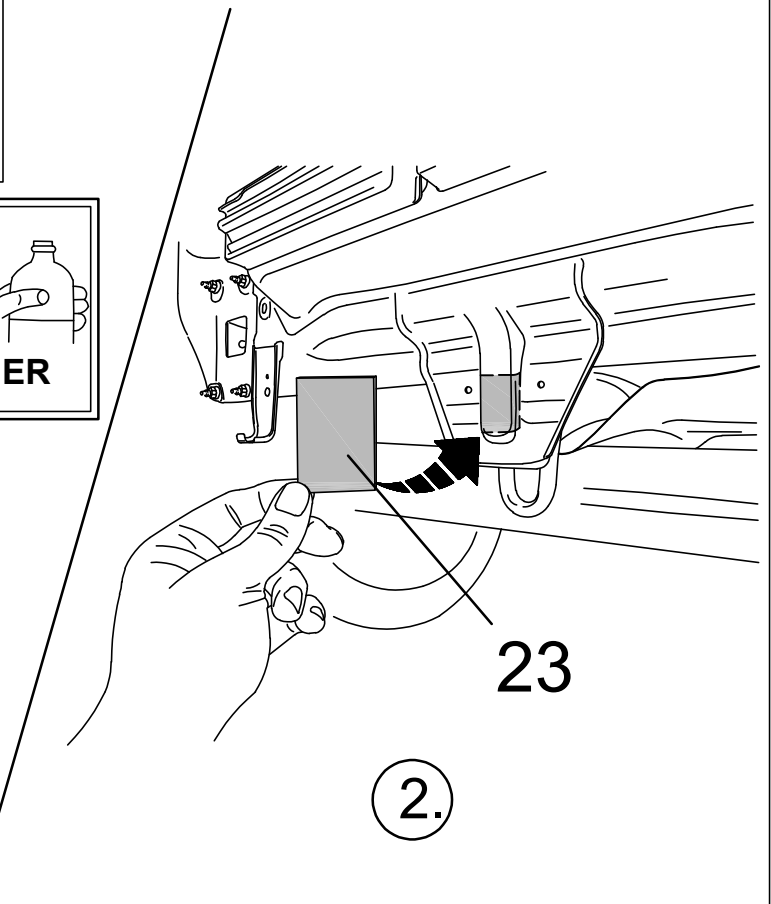
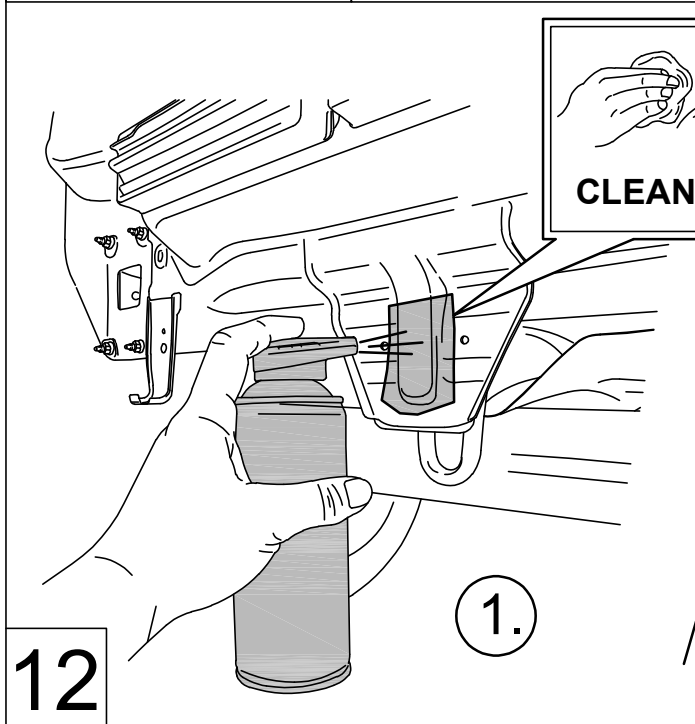
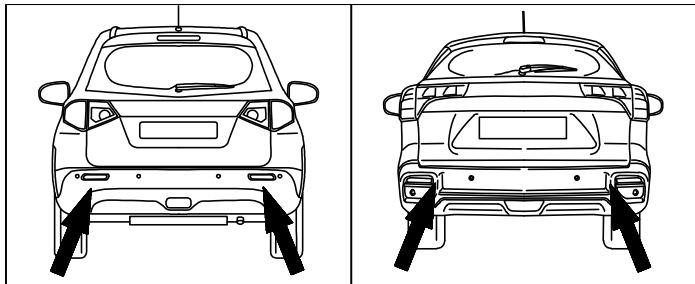

S-Cross

X7

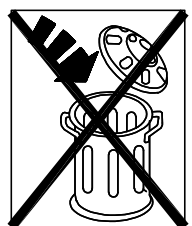
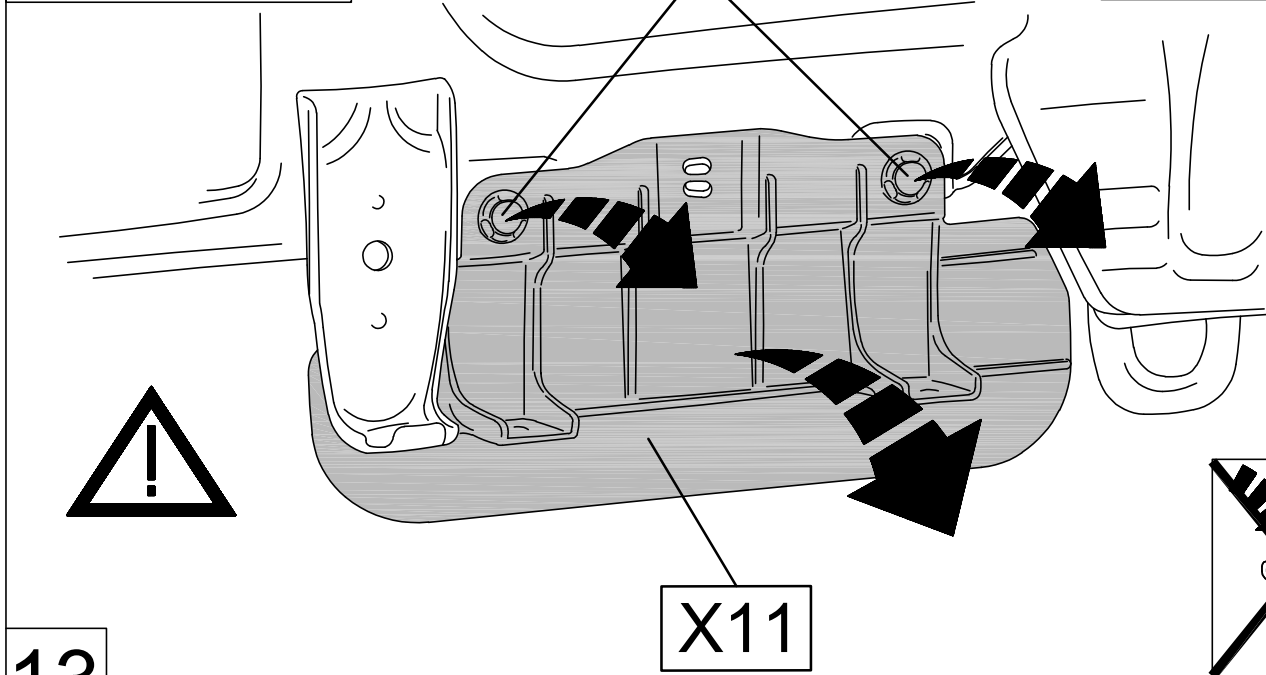
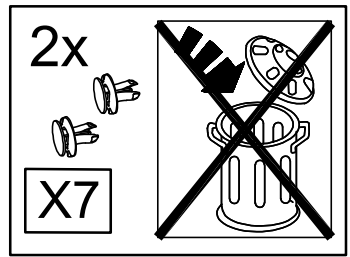

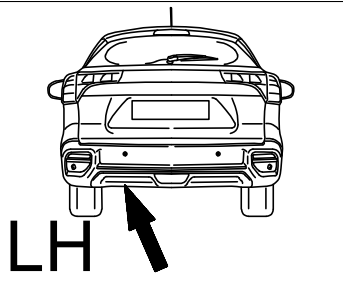

# S-Cross

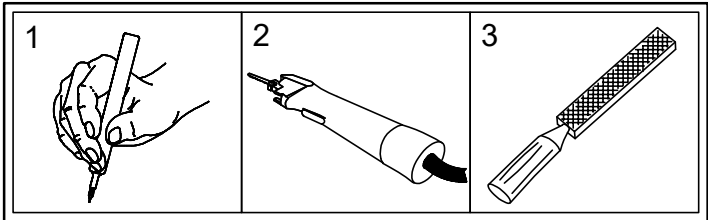

X11

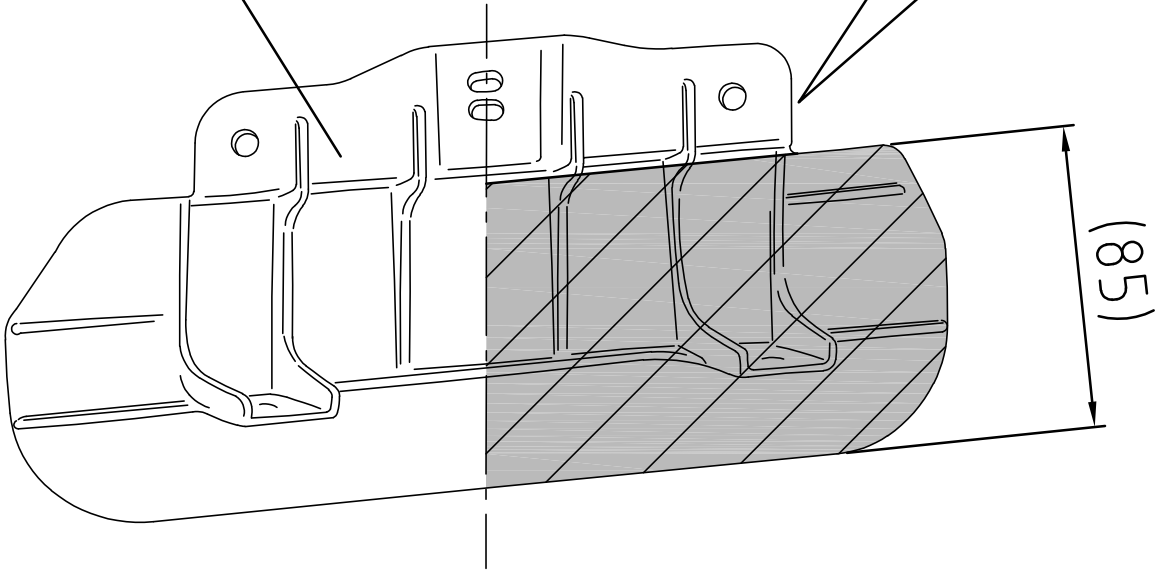

14

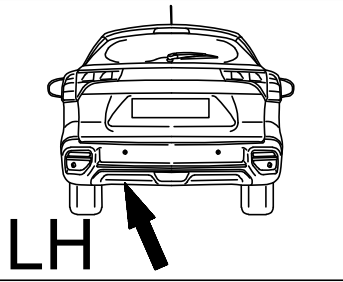

# S-Cross

X7

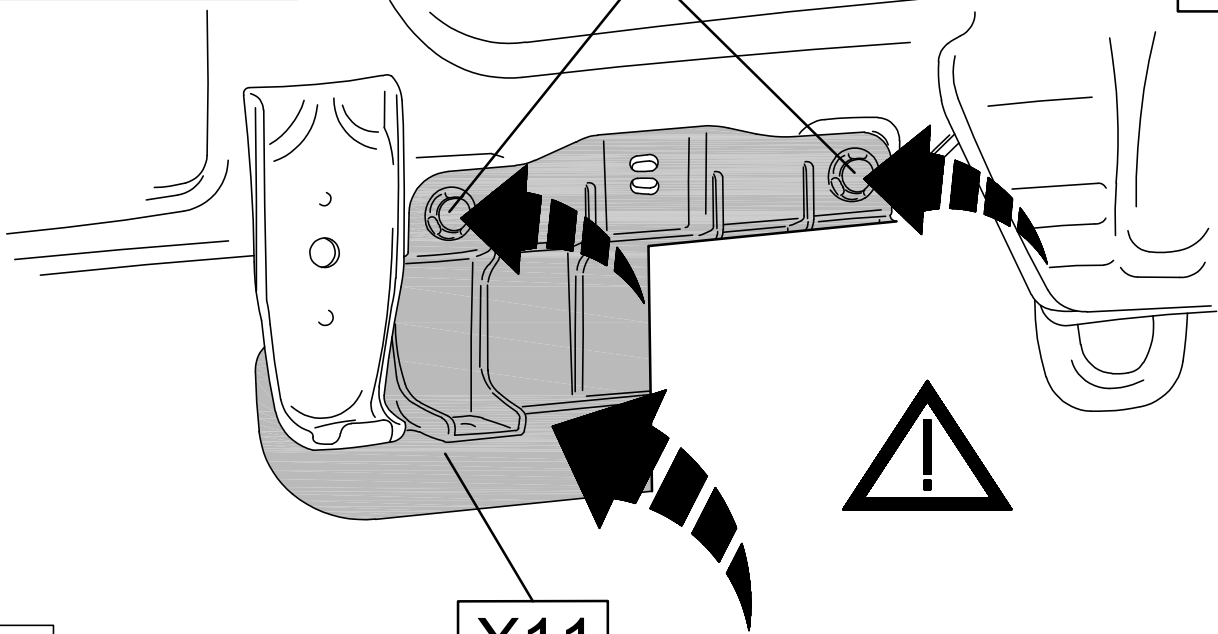
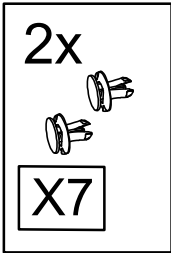

X11

15

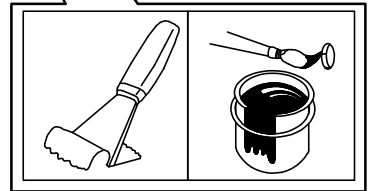
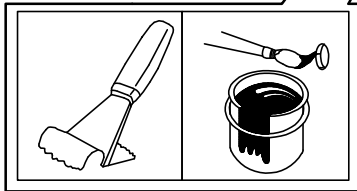
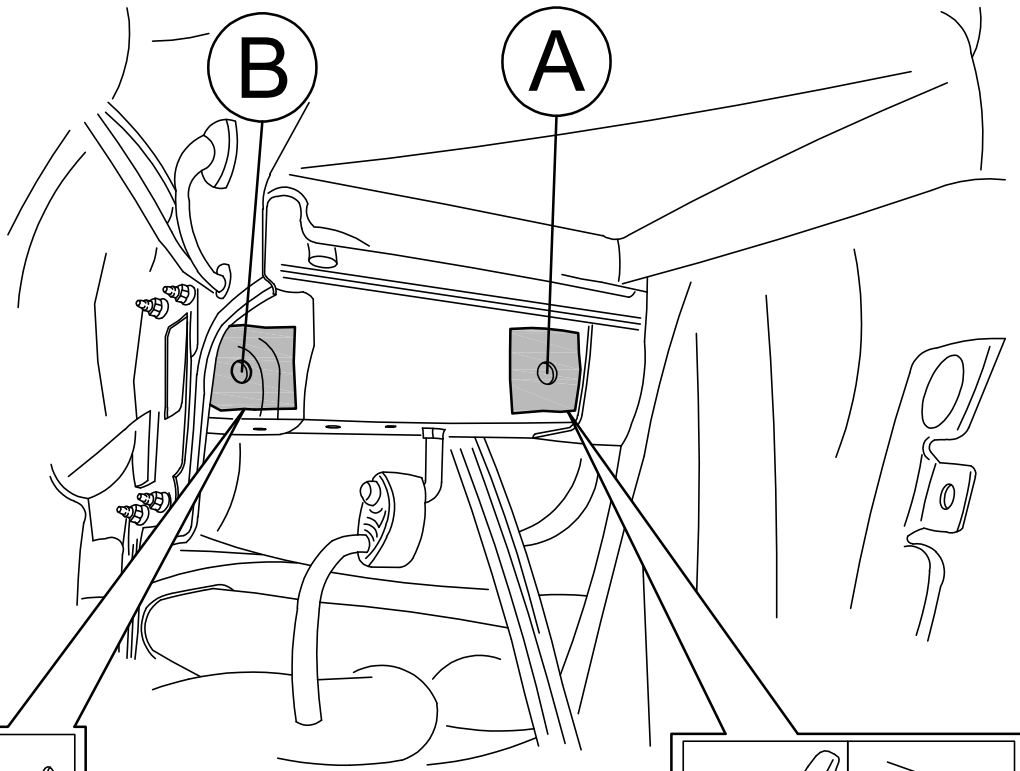
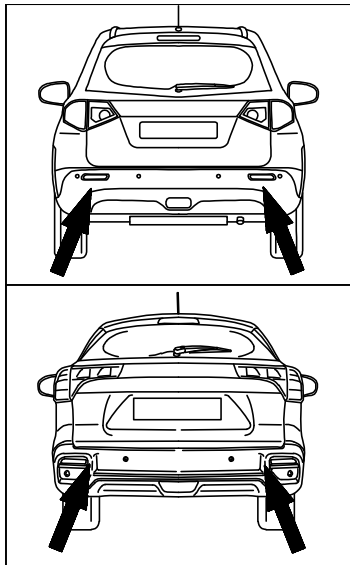

16

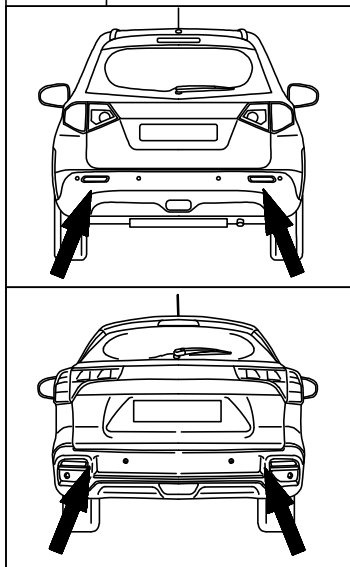

3

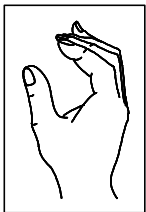
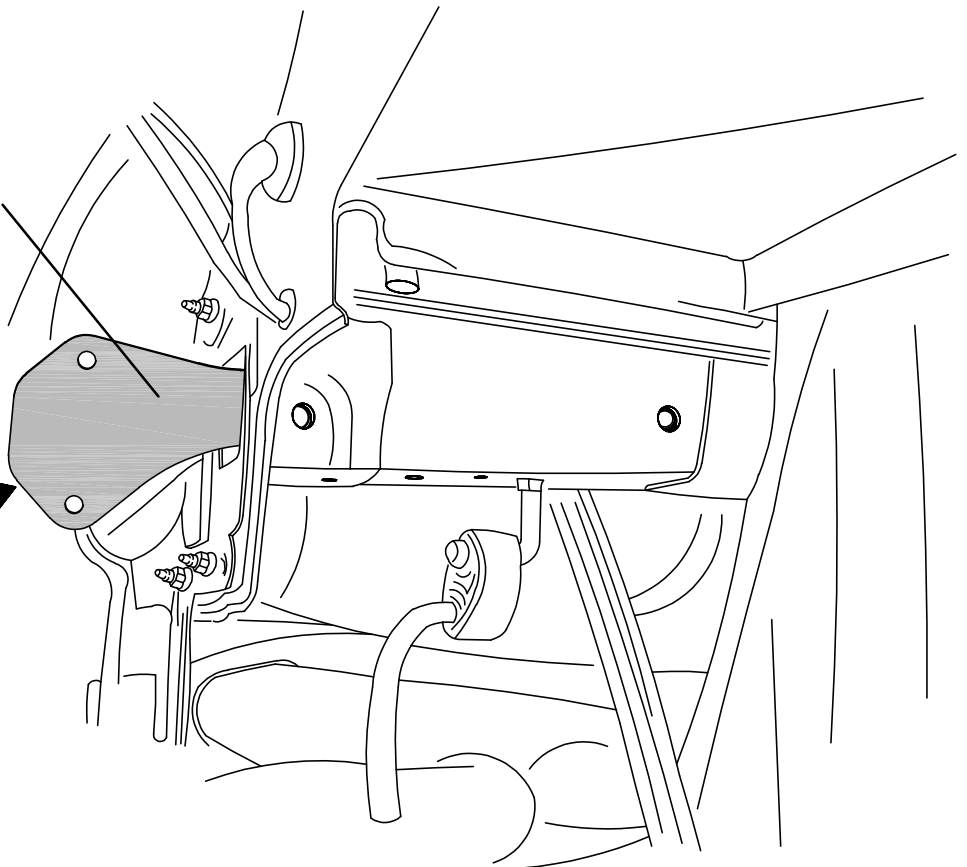

17



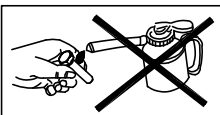
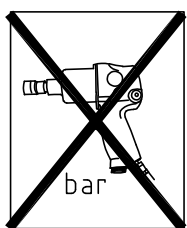
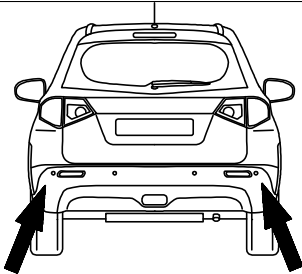

1

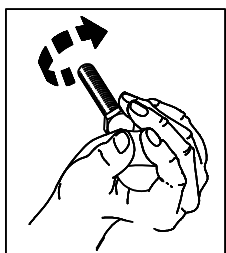
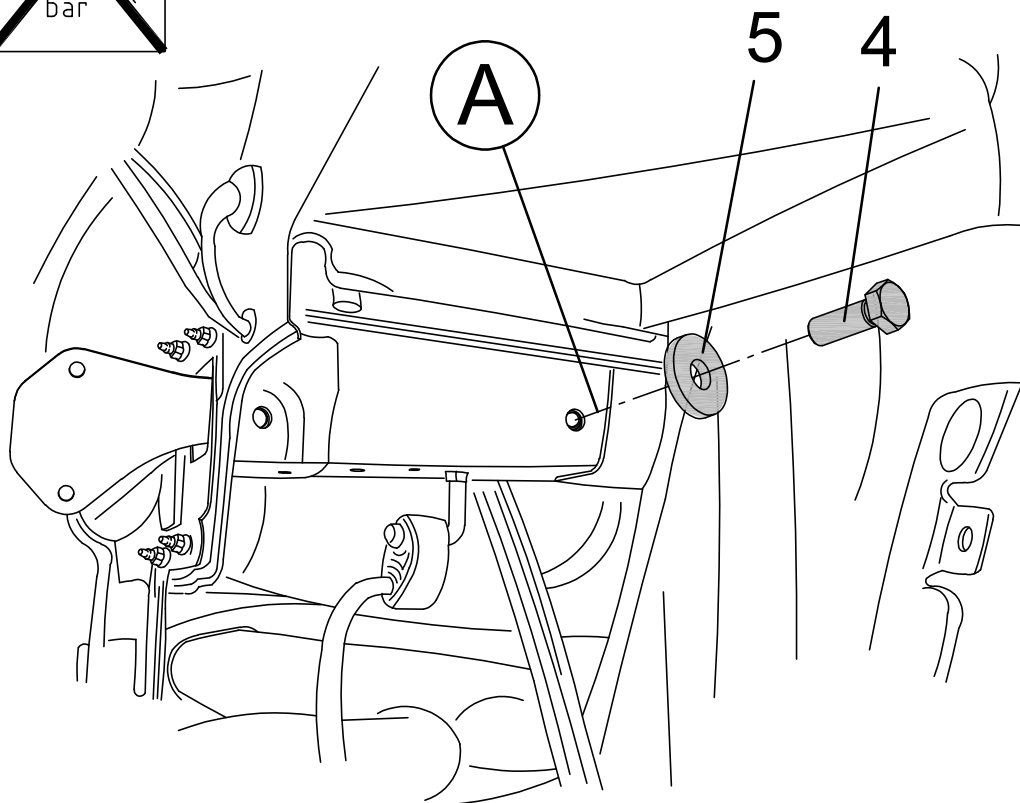
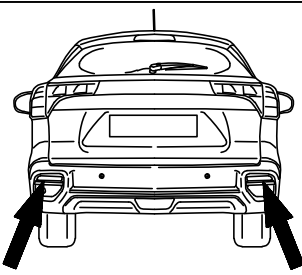

18

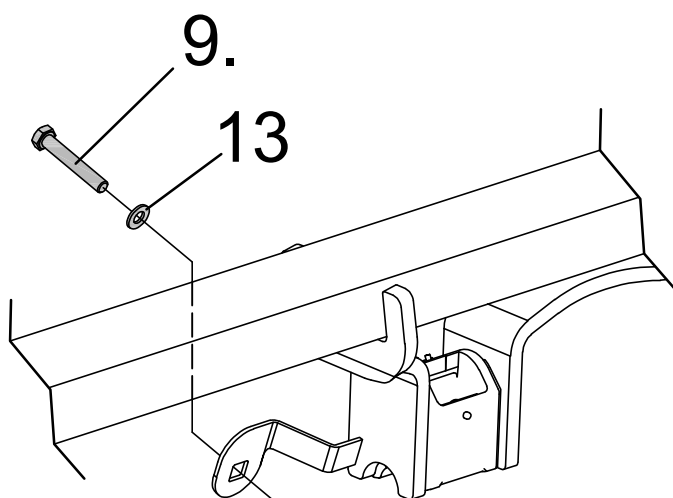
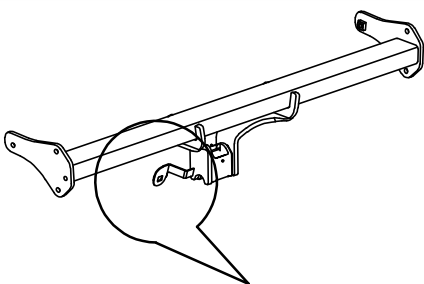

1

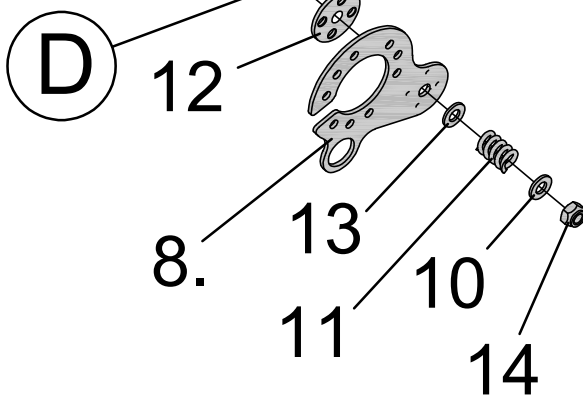
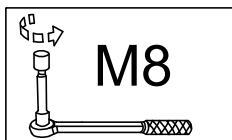
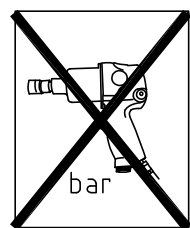
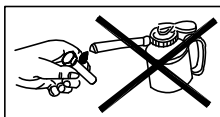

19



1

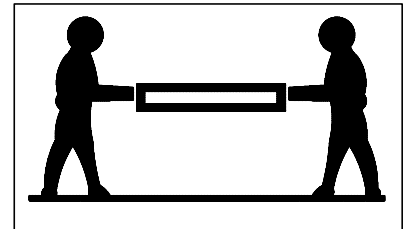
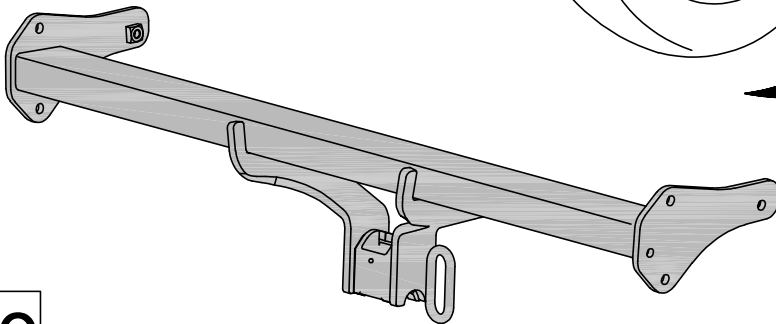
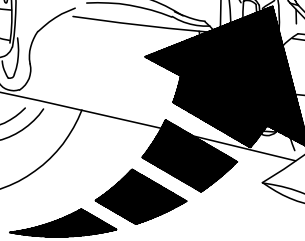

20

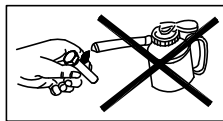
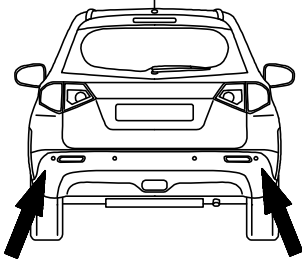

1

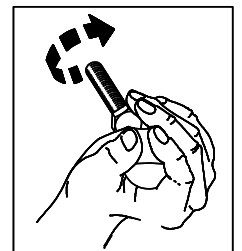
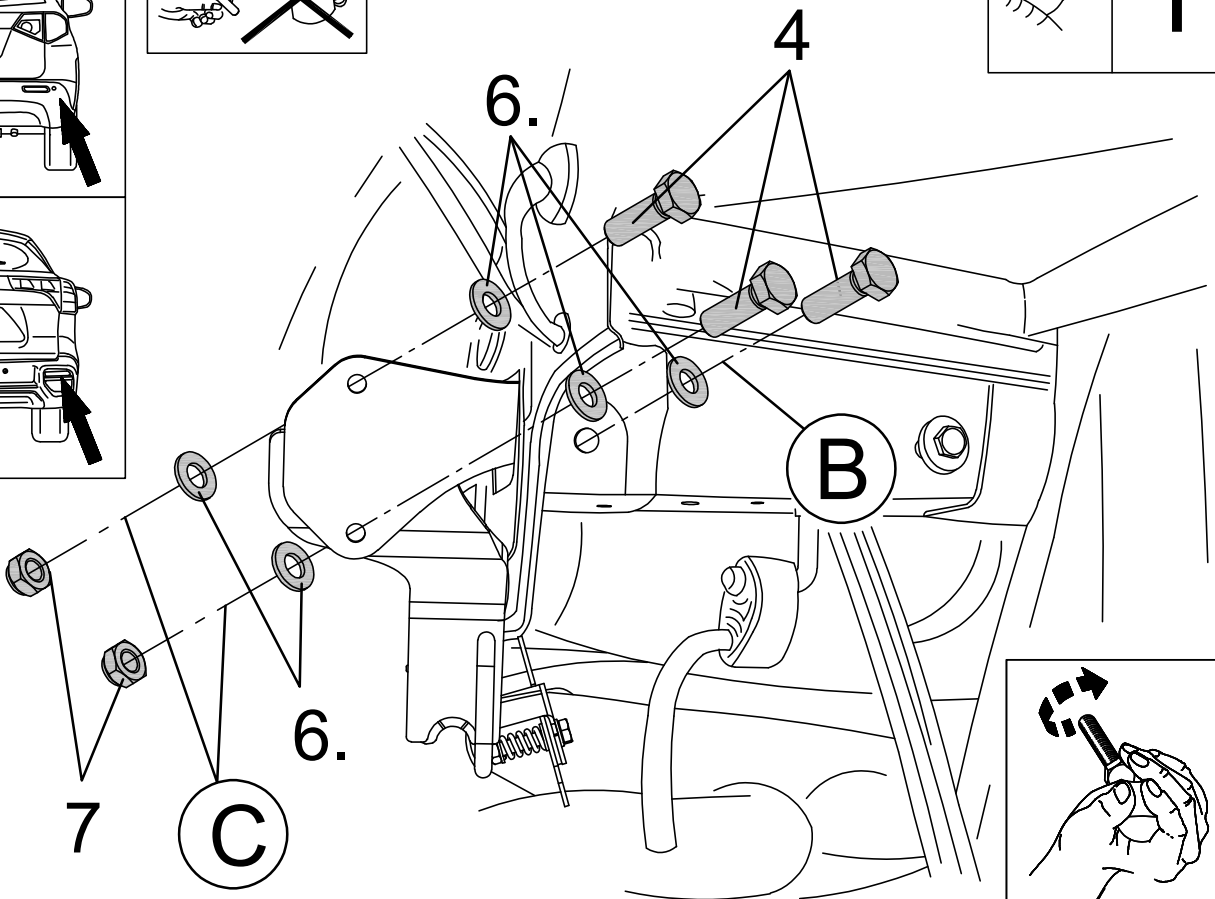
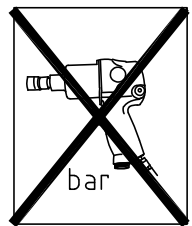
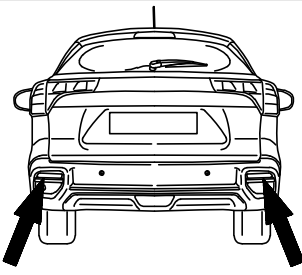

21

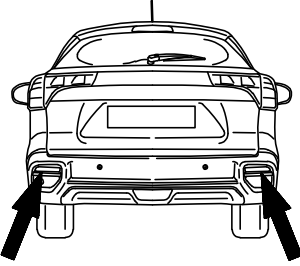
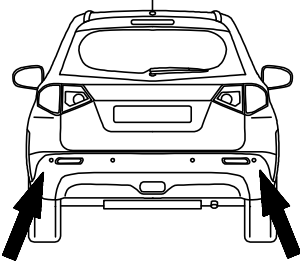

	<b>M10</b>	<b>10.9</b>	<b>60Nm</b>
--	------------	-------------	-------------



	<b>M10</b>	<b>10.9</b>	<b>60Nm</b>
--	------------	-------------	-------------

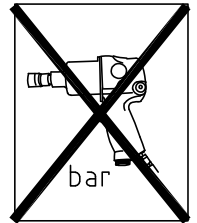

22

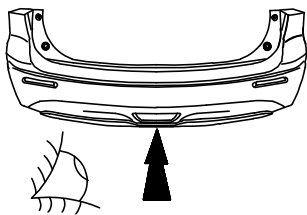

Vitara



1 	2 	3 
-------	-------	-------

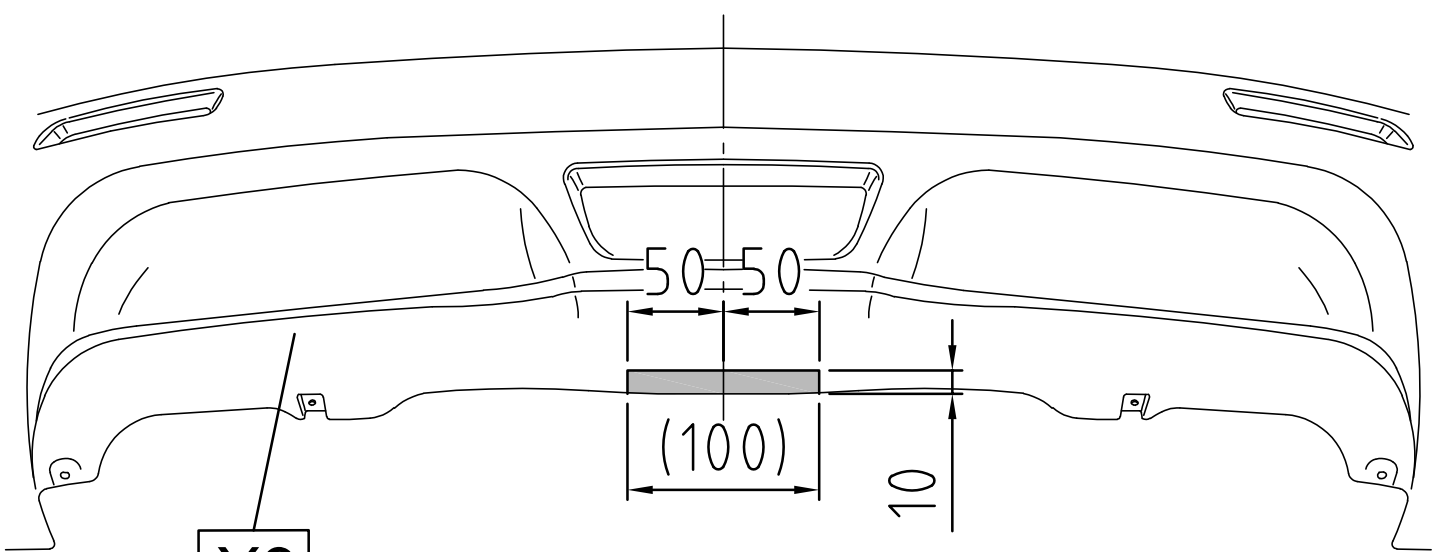

X9

23

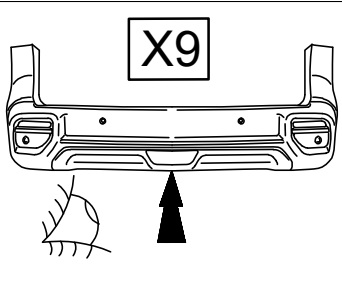

S-Cross

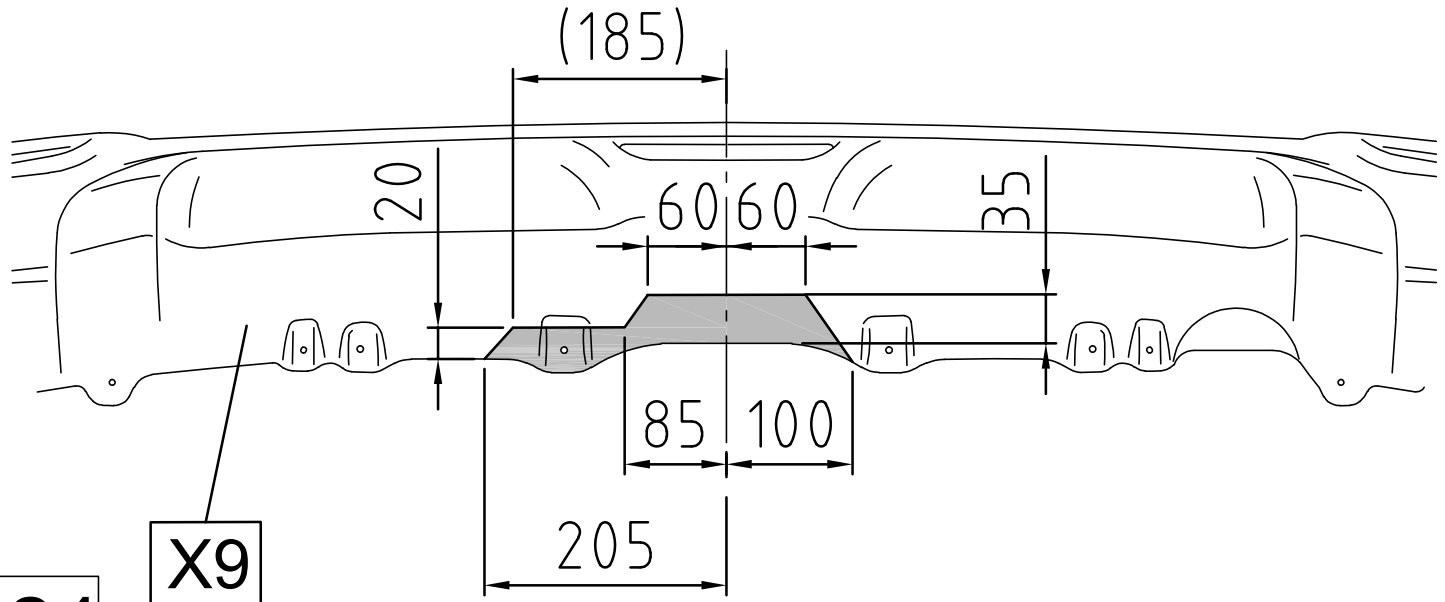
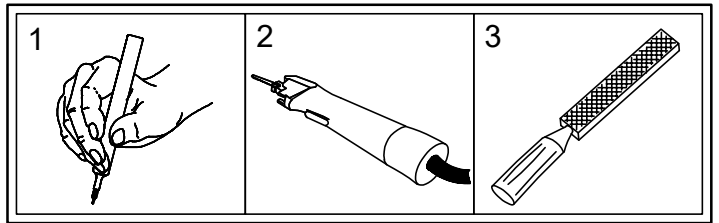

24

**Vor der Komplettierung des Fahrzeuges**  
**⚠ ist der Elektrosatz zu montieren! ⚠**

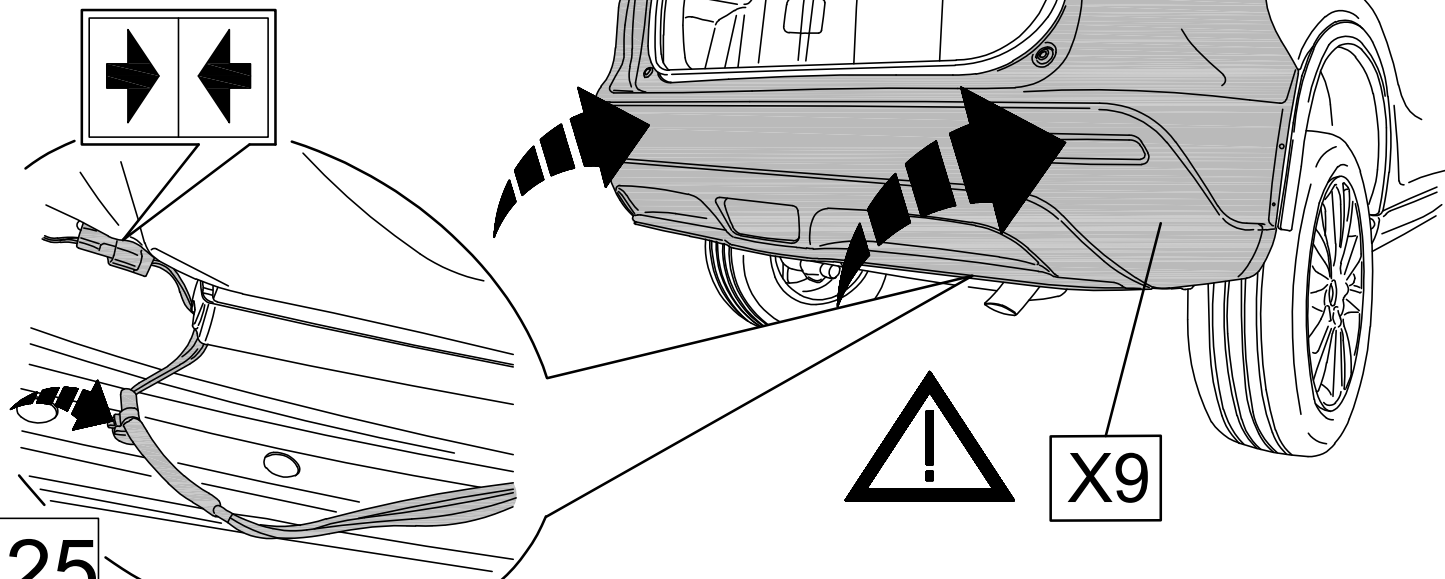
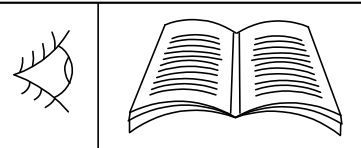

25

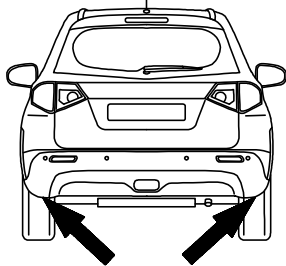

# Vitara

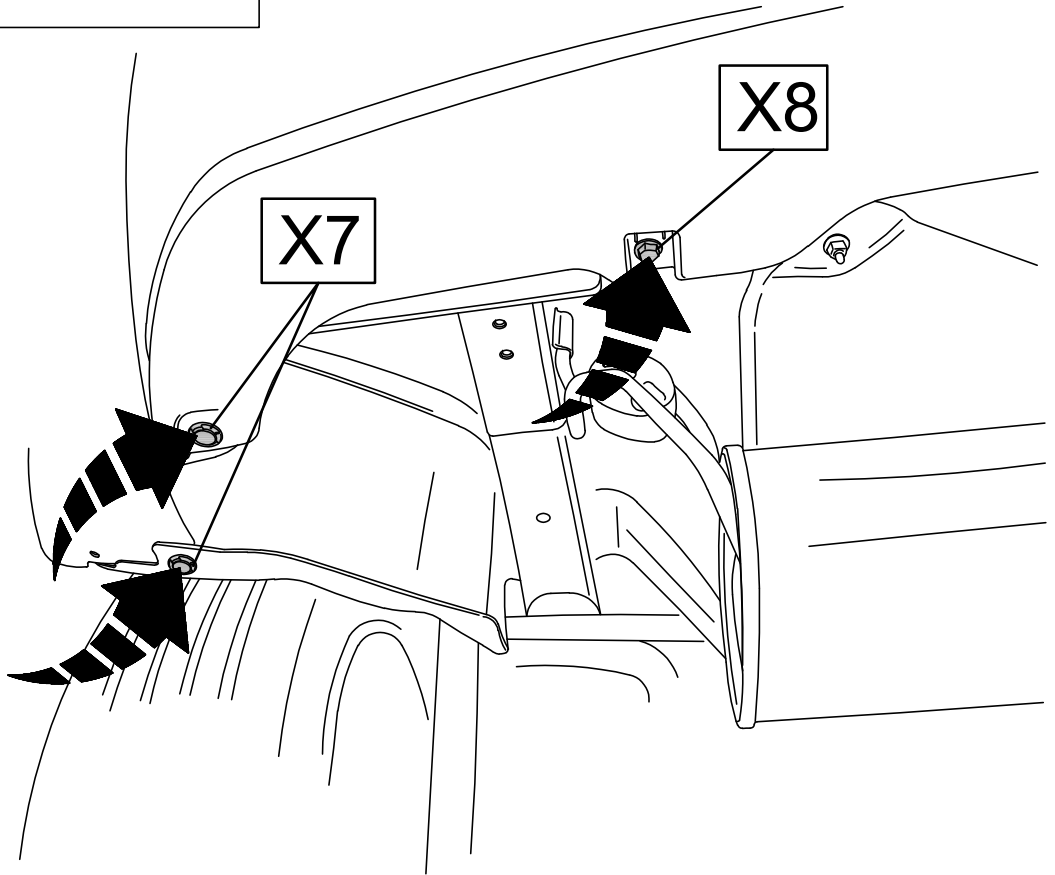
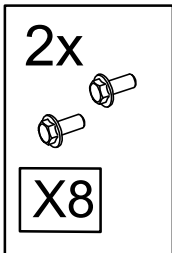
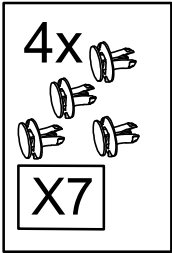

26

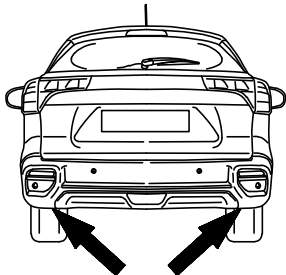

# S-Cross

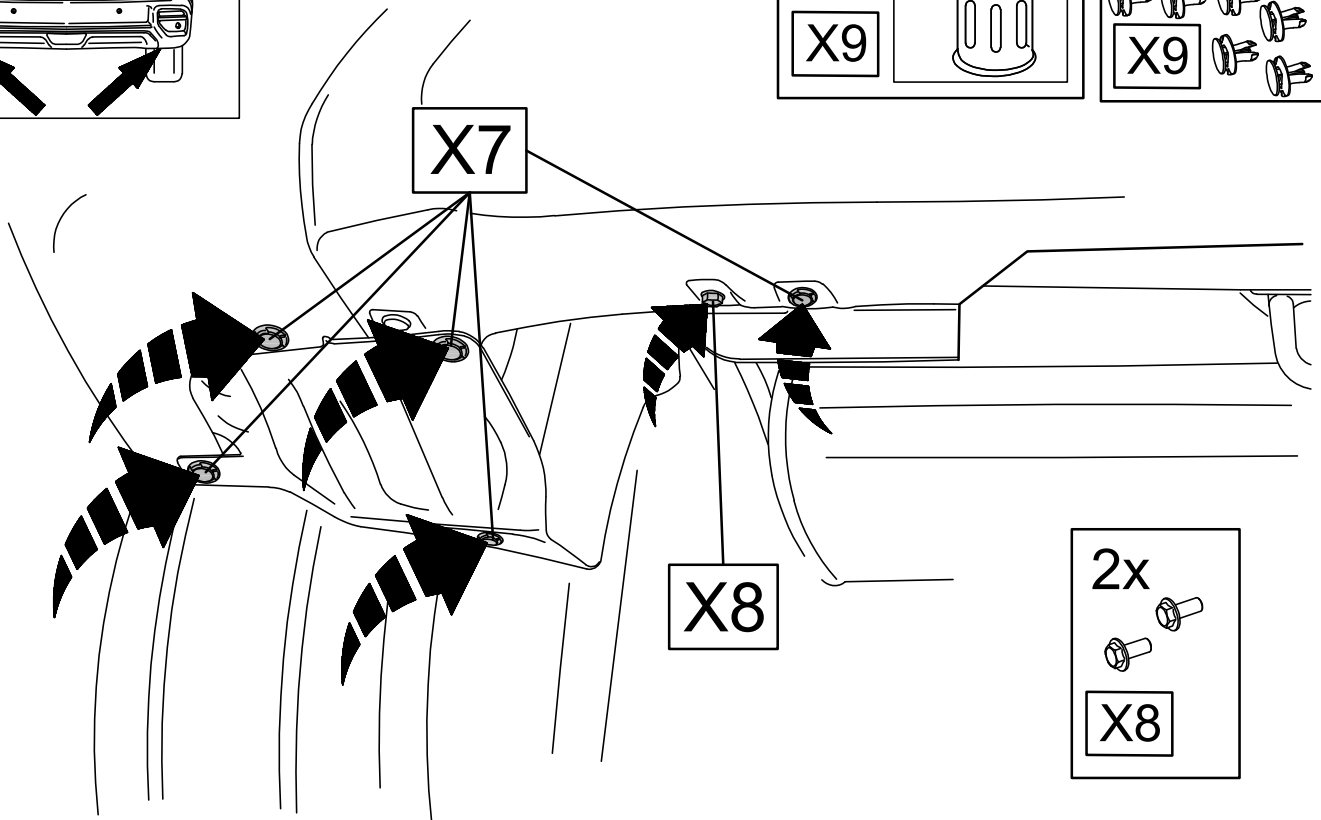
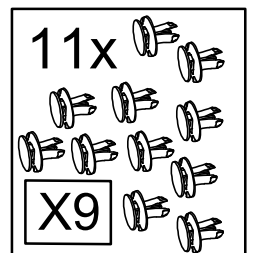
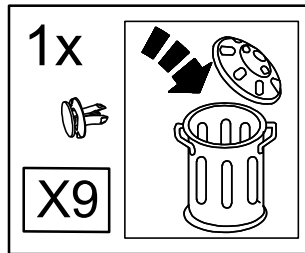

27

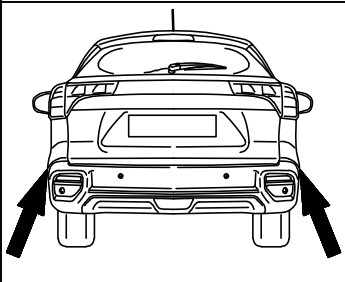
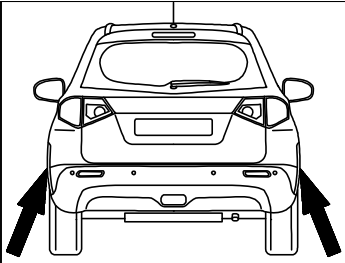

"KLICK"

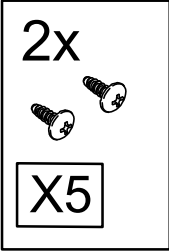
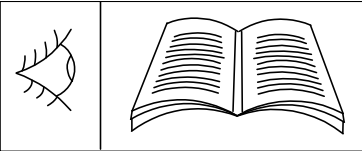

X5

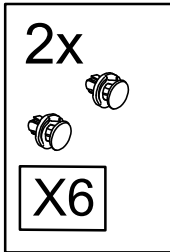
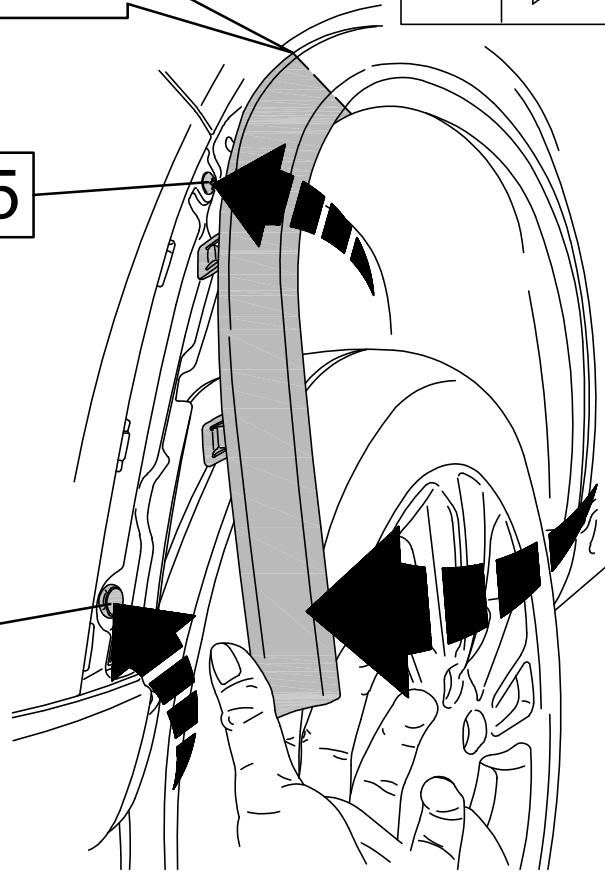

X6

28

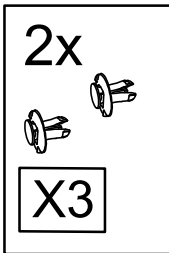
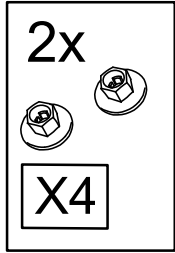
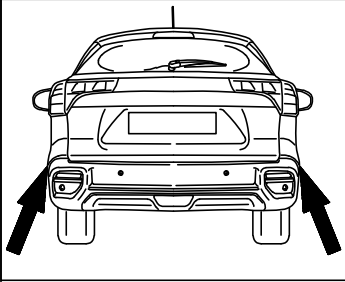
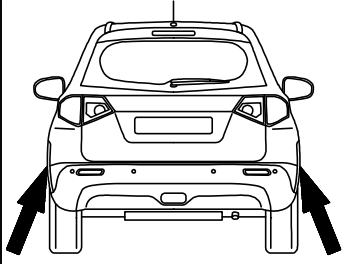

X4

X3

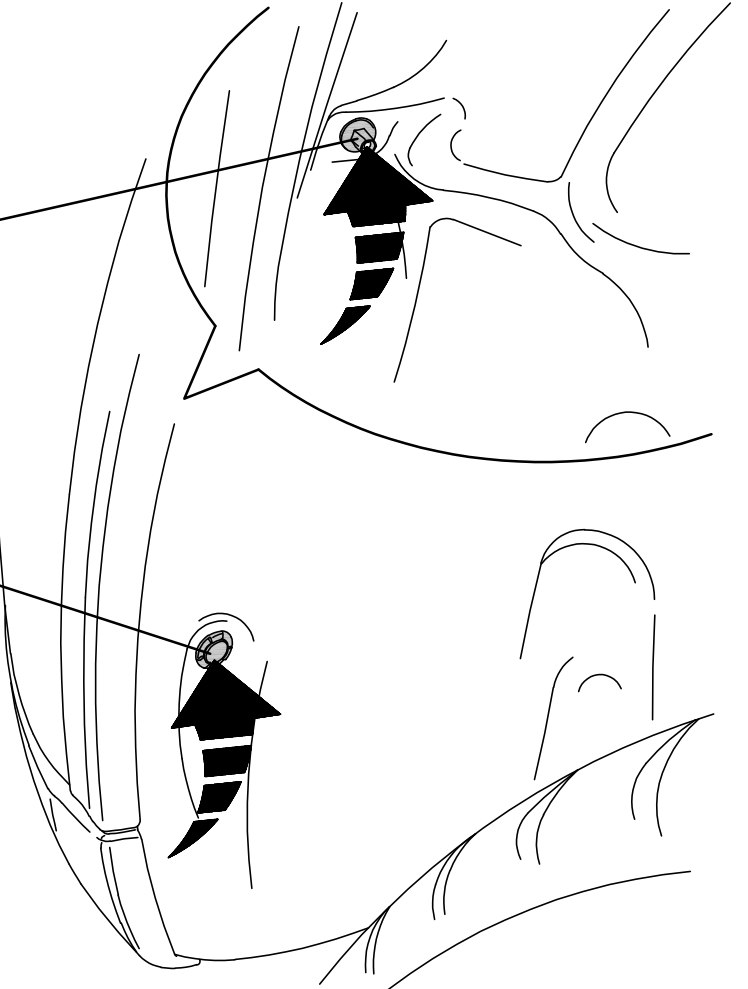

29

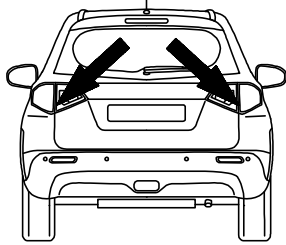

# Vitara

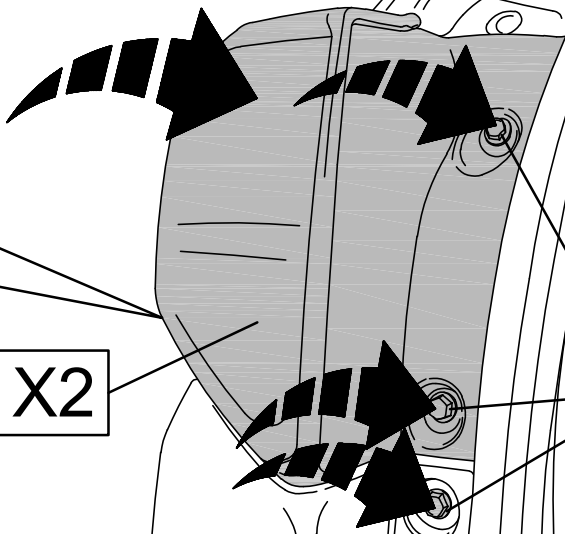
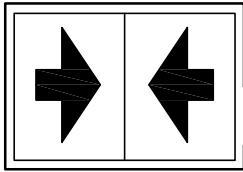

X2

X1

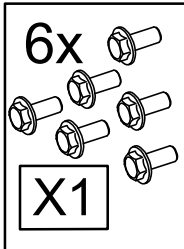

30

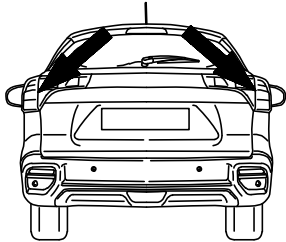

# S-Cross

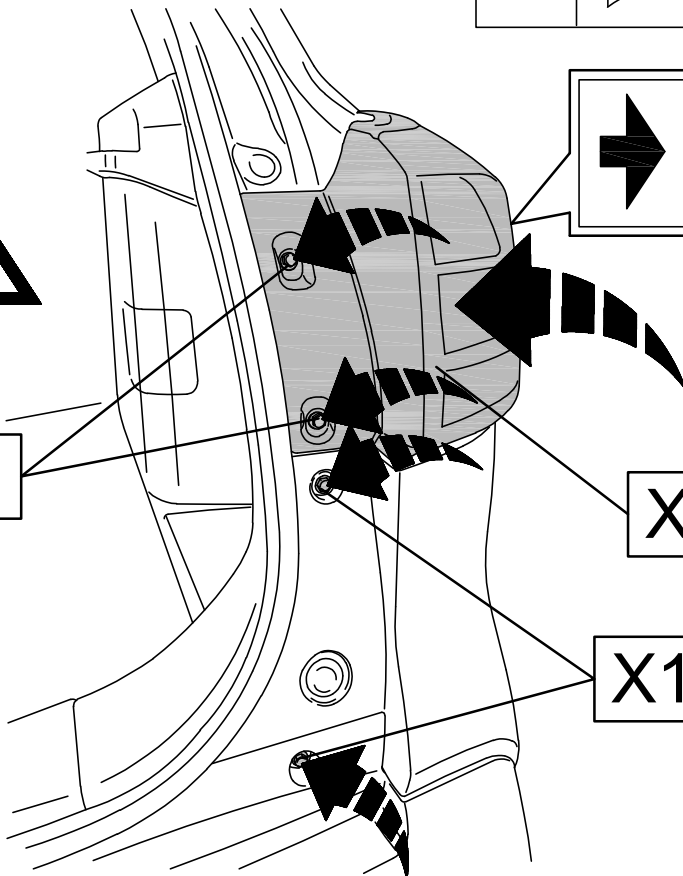
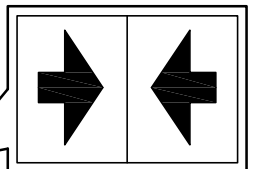
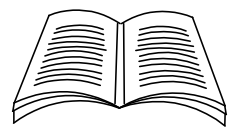

X1

X2

X1

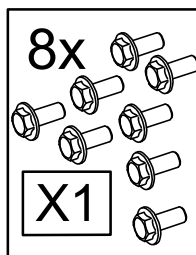

31

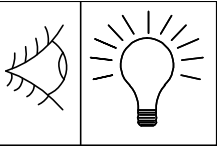

Zulässige Stützlast  
maximal 75 kg



18

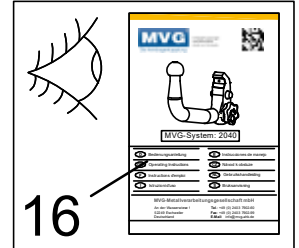
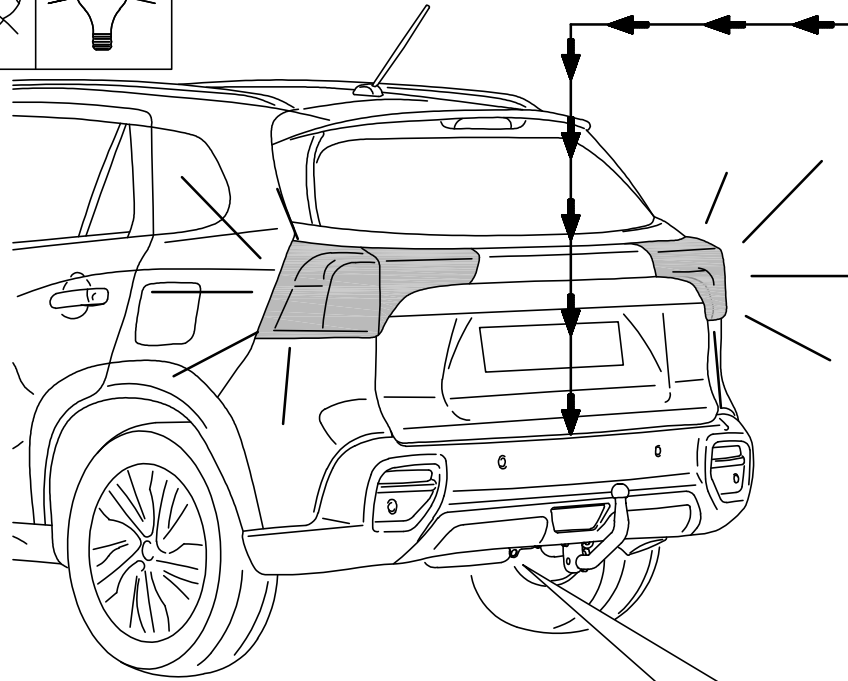

16

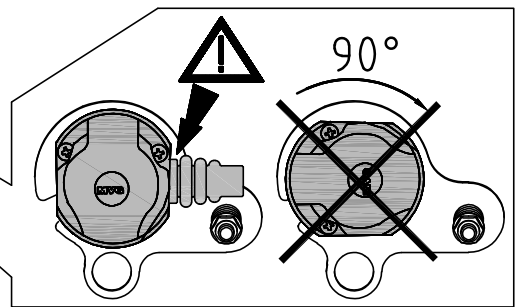

32

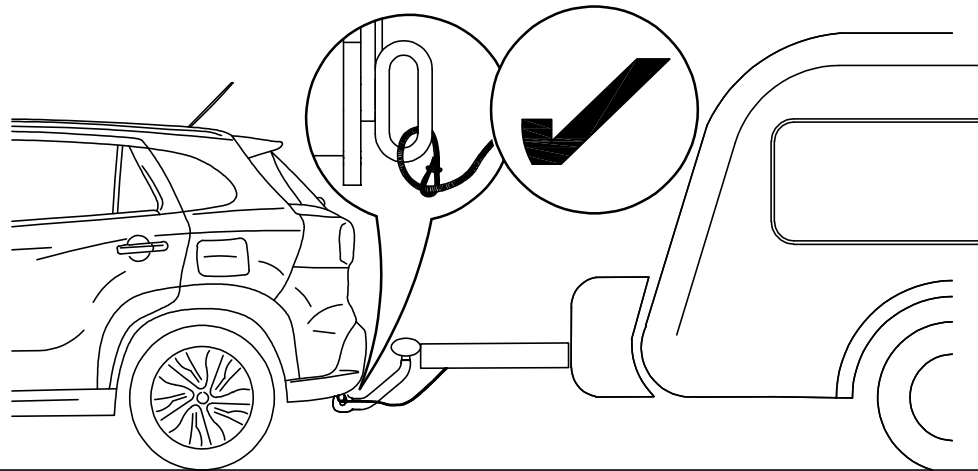
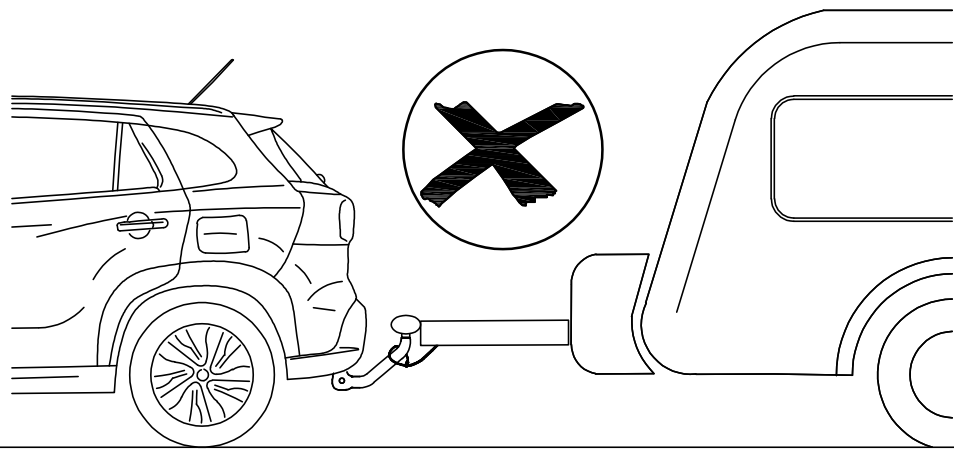

33



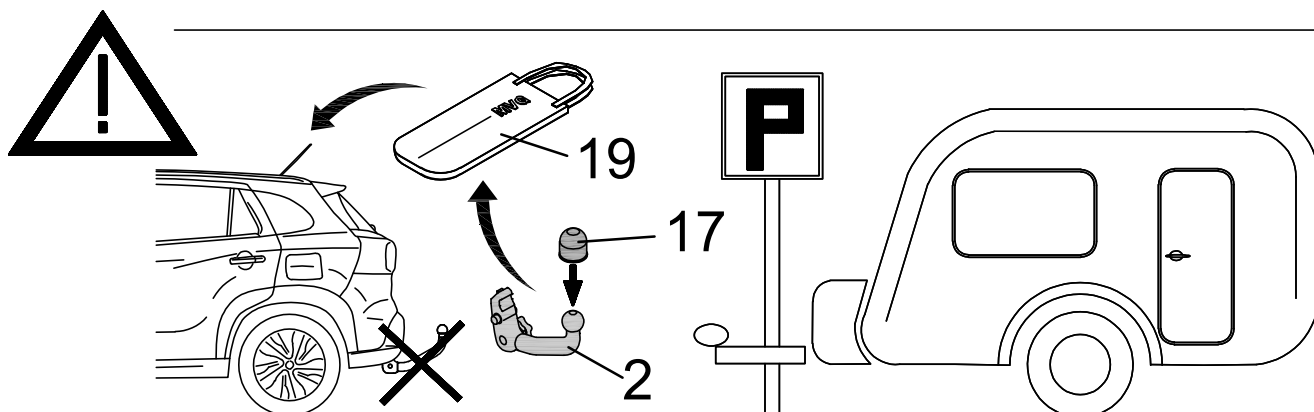
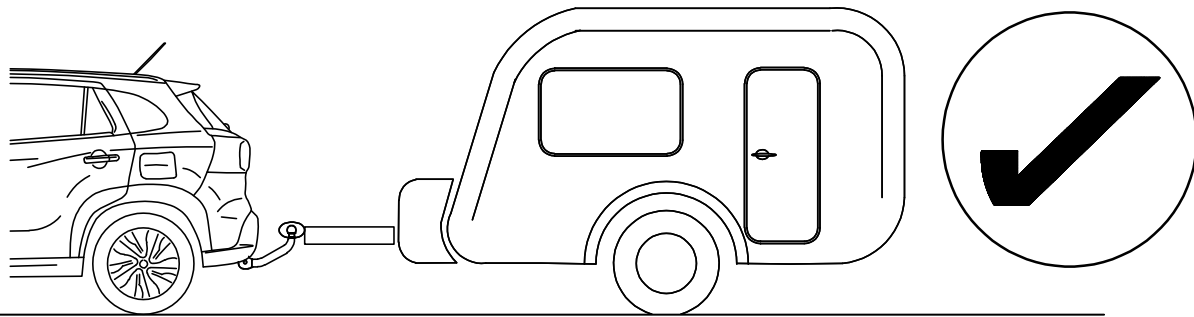

34

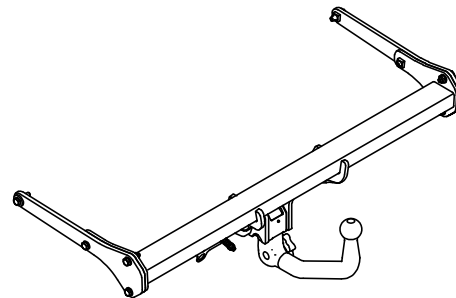
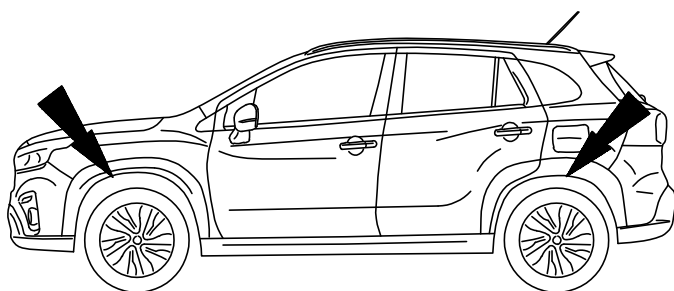

Best. Nr.: 3521 A

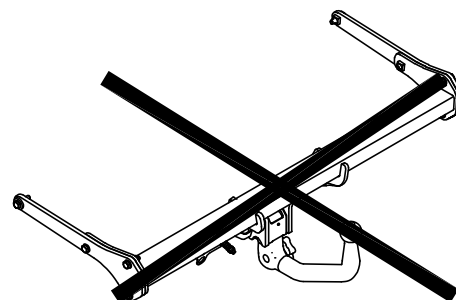
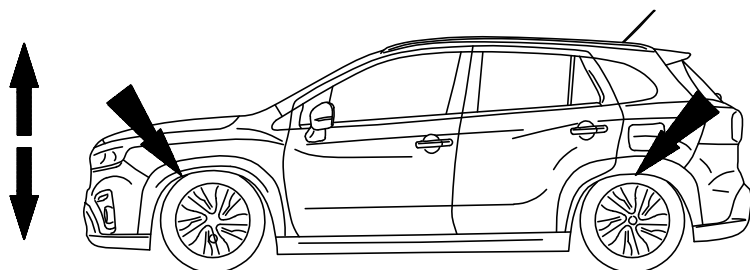

35



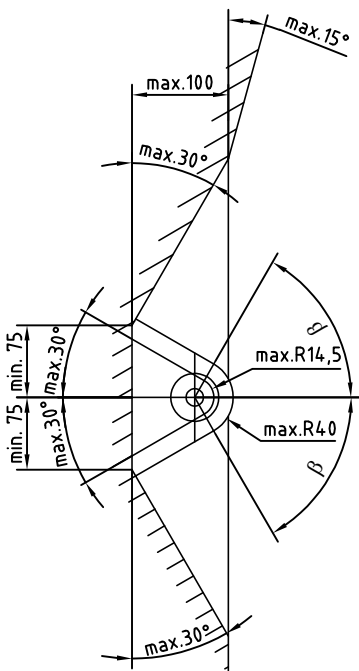
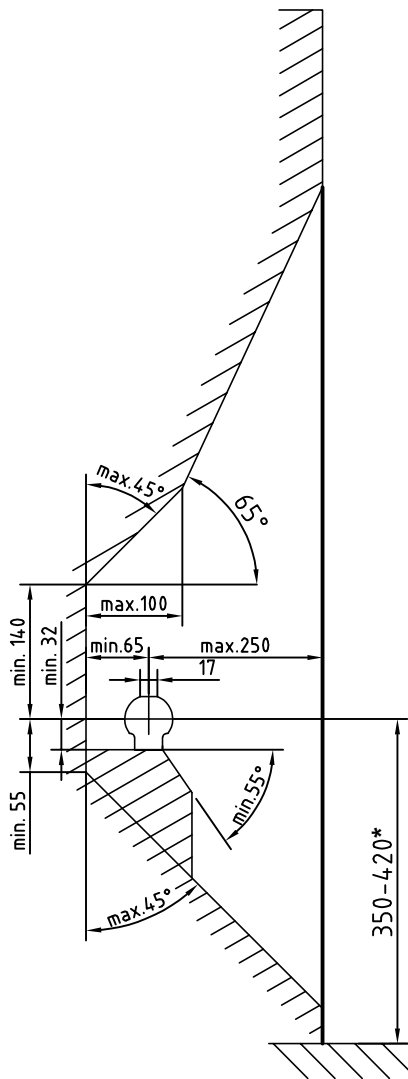

- D** Der Freiraum nach Anhang 7, Abbildung 25a und 25b der Richtlinie ECE-R 55 ist zu gewährleisten.
- CZ** Volný prostor ve smyslu Přílohy 7, obr. 25a a 25b směrnice ECE-R 55 musí být zaručen.
- DK** Det skal sikres, at der er spillerum i overensstemmelse med bilag 7, fig. 25a og 25b i henhold til direktiv ECE-R 55.
- E** Hay que garantizar el espacio libre conforme al anexo 7, fig. 25a y 25b de la directiva ECE-R 55.
- F** La zone de dégagement, selon l'annexe 7, figure 25a et 25b de la directive ECE-R 55, doit être assurée.
- FIN** Välyksen tulee täyttää ohjeen ECE-R 55 liitteen 7 kuvissa 25a ja 25b ilmoitetut vaatimukset.
- GB** Make sure to provide clearance according to appendix 7, figures 25a and 25b of the ECE-R 55 regulations.
- GR** Πρέπει να εξασφαλίζεται ο ελεύθερος χώρος σύμφωνα με το παράρτημα 7, σχήμα 25a και 25b της κοινοτικής οδηγίας ECE-R 55.
- H** Biztosítani kell az ECE-R 55 irányelv szerinti, 7. számú függelék, 25a. és 25b ábrákban jelölt szabad teret.
- I** Deve essere garantito lo spazio libero secondo l'allegato 7, figure 25a e 25b della normativa europea ECE-R 55.
- N** Det må sørges for fritt rom i samsvar med tillegg 7, figur 25a og 25b i direktiv ECE-R 55.
- NL** De vrije ruimte volgens supplement 7, afbeelding 25a en 25b van richtlijn ECE-R 55 moet gewaarborgd zijn.
- PL** Należy zapewnić wolną przestrzeń zgodnie z załącznikiem 7, rys. 25a i 25b, dyrektywy ECE-R 55.
- RUS** Оставлять свободное пространство согласно Приложению 7, рис. 25a и 25b Директивы ECE-R 55.
- S** Spelrummet enligt bilaga 7, bild 25a och 25b i riktlinje ECE-R 55, måste garanteras.

- D** \* bei zulässigem Gesamtgewicht des Fahrzeuges
- CZ** \* při celkové přípustné hmotnosti vozidla
- DK** \* ved tilladt totalvægt for køretøjet
- E** \* con peso total autorizado del vehículo
- F** \* pour poids total en charge autorisé du véhicule
- FIN** \* Ajoneuvon suurimmalla sallitulla kokonaispainolla
- GB** \* at gross vehicle weight rating
- GR** \* για το επιτρεπτό μικτό βάρος του οχήματος
- H** \* A jármű megengedett összsúlya esetén
- I** \* per il peso complessivo ammesso del veicolo
- N** \* ved kjøretøyets tillatte totalvekt
- NL** \* bij toegestaan totaal gewicht van het voertuig
- PL** \* przy dopuszczalnym ciężarze całkowitym pojazdu
- RUS** \* при допустимом общем весе автомобиля
- S** \* vid fordonets tillåtna totalvikt

- D** Die Anhängervorrichtung ist ein Sicherheitsteil und darf nur von Fachunternehmen montiert werden. Bei falscher Montage besteht schwere Unfallgefahr! Der deutsche Text dieser Anleitung ist bindend.
- CZ** Tažné zařízení je bezpečnostní součást, kterou smí montovat pouze odborné podniky. Při chybné montáži hrozí vážné nebezpečí nehody! Německý text tohoto návodu je závazný.
- DK** Anhængertrækket er en sikkerhedsdel og må kun monteres af autoriserede firmaer. Ved forkert montering er der fare for alvorlige uheld! Den tyske tekst i denne vejledning er bindende.
- E** La bola de engancho es un elemento de seguridad y sólo se debe permitir su montaje a personal cualificado. ¡En caso de montaje erróneo existe peligro de accidentes graves! Es vinculante el texto alemán de estas instrucciones.
- F** Le dispositif d'attelage est un équipement de sécurité et doit être mis en place exclusivement par un atelier spécialisé. Un montage incorrect représente un risque élevé d'accident! Le texte allemand de cette notice fait foi.
- FIN** Vetolaite on turvallisuuteen vaikuttava osa, jonka saa asentaa vain alan erikoisliike. Virheellinen asennus voi aiheuttaa vakavan onnettomuuden! Tämän ohjeen saksankielinen teksti on sitova.
- GB** A trailer hitch is a safety-critical part and may be fitted only by qualified companies. Improper assembly may result in a serious accident hazard! The German text of this instruction is binding.
- GR** Ο κοτσαδόρος είναι ένα εξάρτημα ασφαλείας και η τοποθέτηση του επιτρέπεται να γίνεται μόνο από εξειδικευμένο συνεργείο. Σε περίπτωση λάθους τοποθέτησης υπάρχει κίνδυνος σοβαρών ατυχημάτων! Το γερμανικό κείμενο αυτών των οδηγιών είναι δεσμευτικό.
- H** A vonószerkezet egy biztonsági felszerelés, amelyet csak szaküzem szerelhet fel. Helytelen szerelés súlyos balesethez vezethet! A német szerelési utasítás betartása kötelező.
- I** Il gancio di traino è un componente di sicurezza e deve essere montato esclusivamente da personale specializzato. In caso di montaggio errato sussiste il pericolo di incidenti gravi! È vincolante il testo tedesco di queste istruzioni.
- N** Tilhengerfestet er en sikkerhetskompoment og skal monteres av fagbedrift. Det er stor fare for at det kan oppstå ulykker ved feil montering! Den tyske teksten i denne veiledningen er bindende.
- NL** De aanhanger is veiligheidsonderdeel en mag alleen door vakkundig personeel worden gemonteerd. Bij verkeerde montage bestaat ernstig gevaar voor ongevallen! De Duitse tekst van deze handleiding is bindend.
- PL** Hak holowniczy stanowi element bezpieczeństwa i może zostać zamontowany wyłącznie przez firmę specjalistyczną. W przypadku nieprawidłowego montażu istnieje poważne ryzyko wypadku! Tekst niniejszej instrukcji w języku niemieckim jest wiążący.
- RUS** Сцепное устройство - это узел, несущий предохранительные функции, и к его монтажу допускаются только специалисты. При неправильном монтаже грозит опасность тяжелых травм! Обязательным является немецкий текст данной инструкции.
- S** Dragkroken är en säkerhetskompoment och bör endast monteras av kvalificerade tekniker. Vid felaktig montering föreligger risk för allvariga olyckor! Den tyska texten i denna anvisning är bindande.

Dispositivo di traino tipo:

**3521 A**

Per autoveicoli:

**Suzuki Vitara 10/2018 → (LY)  
Suzuki S-Cross 01/2022 → (JY)**  
(Tipo funzionale)

Classe e tipo di attacco:

**CLASS A50-X**

Omologazione:

**E4 55R-01 1113**

Valore D:

**8,5 kN**

Carico verticale max. S:

**90 kg**

Larghezza rimorchiabile per Caravan e T.A.T.S.: 2,45 m vedere CARTA di CIRCOLAZIONE VEICOLO (motrice) + 70 cm = arrotondare ai 5 cm superiore (vedi D.M. 28/05/85)

Massa rimorchiabile:

**Vedi carta circolazione dell' autoveicolo**

$$D = ((T \times C) / (T+C)) \times 0,00981 = 8,5 \text{ kN} < D$$

Per verificare l'idoneità del dispositivo di traino omologato a norma ECE-R55, all'installazione sulla vettura su cui si intende procedere al montaggio,

compilare la seguente formula (se necessario declassare la massa rimorchiabile):

dove:  $T =$  Massa Complessiva Max. della motrice (in kg)  
 $C =$  Massa Rimorchiabile Max. della motrice (in kg)

### DA COMPILARE PER IL COLLAUDO

**DICHIARAZIONE DI CORRETTO MONTAGGIO:** la sottoscritta Ditta dichiara di aver montato in maniera corretta ed in conformità alle prescrizioni sia del costruttore del veicolo che del costruttore del dispositivo stesso il seguente dispositivo di attacco meccanico:

Tipo: .....

Il dispositivo di attacco sopra indicato è stato installato su autoveicolo

Modello: .....

Targa: .....

Data: .....

**TIMBRO e FIRMA**

Si dichiara inoltre di aver informato l'utente del veicolo sull'USO e MANUTENZIONE del dispositivo stesso.







Die Bedienungsanleitung als Video finden Sie unter folgendem Link:

This instruction manual can be found as an illustrating video under the following link:

<https://mvg.li/2040>

Außerdem können Sie mit Ihrem Smartphone den Video-Link durch diesen QR-Code direkt scannen und das Video ansehen.

Furthermore, the link to the video can be scanned and watched via this QR code by the use of your smartphone.



[www.mvg-ahk.de](http://www.mvg-ahk.de)  
[www.mvg-ahk.at](http://www.mvg-ahk.at)  
[www.mvg-ahk.ch](http://www.mvg-ahk.ch)  
[www.mvg-ahk.com](http://www.mvg-ahk.com)