

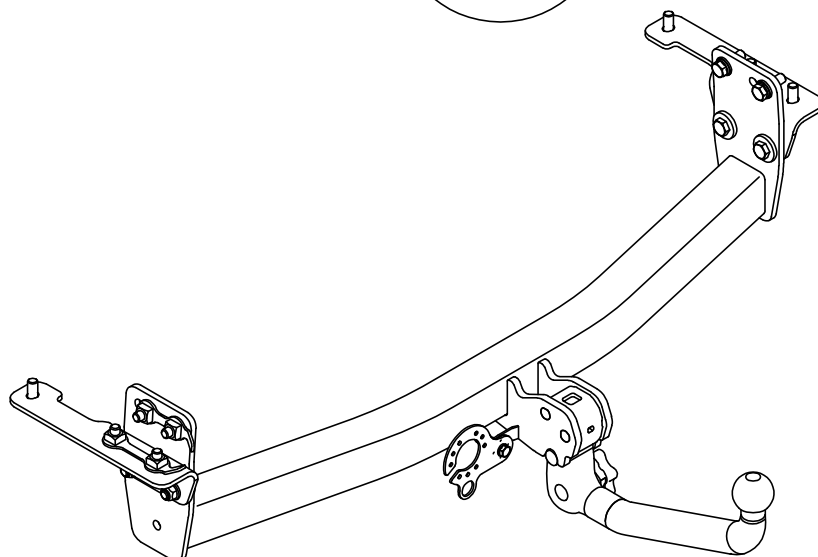

Die Anhängerkupplung.

Anhängerkupplungen  
und Elektrosätze direkt  
vom Hersteller

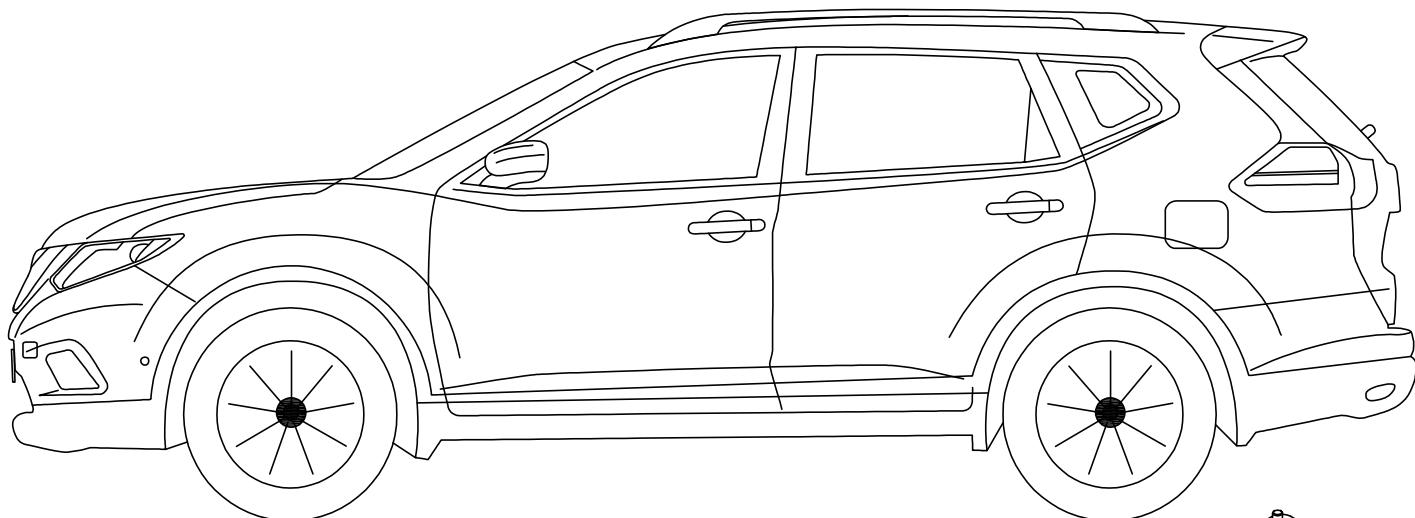

**MVG: 2723 C**

**Nissan X-Trail  
(T32) ab 2014 →**

**E** Instrucciones de montaje

**D** Einbauanleitung

**GB** Installation instruction

**F** Notice de montage

**NL** Inbouw instructie

**S** Monteringsanvisning

**CZ** Návod k montáži

**I** Istruzioni di montaggio

An der Wasserwiese 1  
D-52249 Eschweiler

[info@mvg-ahk.de](mailto:info@mvg-ahk.de)  
[www.mvg-ahk.de](http://www.mvg-ahk.de)

Tel.: (02403)7902-60  
Fax: (02403)7902-99

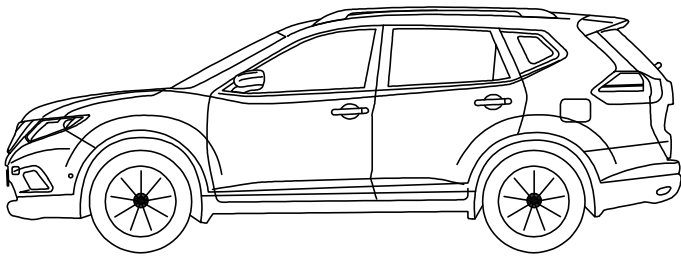

↓ ≤ 2350 kg



EG

e13 \* 2007/46 \* 1456

$$D = 10,8 \text{ kN}$$



≤ 75 kg  
≤ 100 kg

kg ?

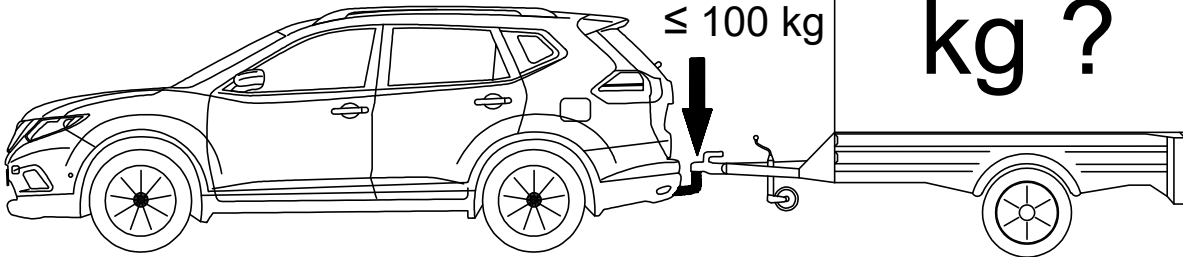

$$D = \frac{T \times R}{1000 \times (T + R)} \times g$$

$$g = 9,81 \text{ m/s}^2$$

$$T = \frac{R \times D \times 1000}{(g \times R) - (1000 \times D)}$$

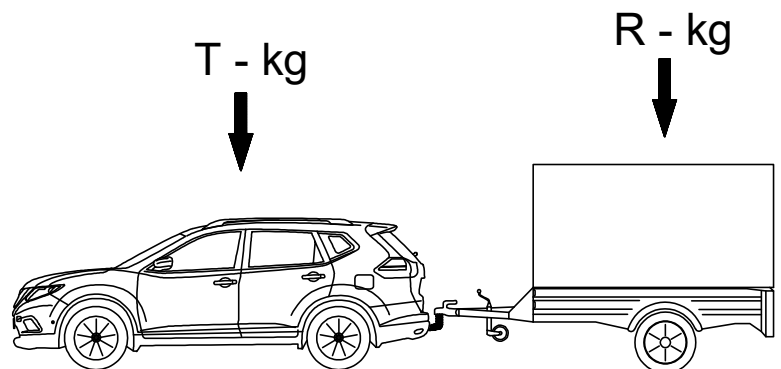

$$R = \frac{T \times D \times 1000}{(g \times T) - (1000 \times D)}$$

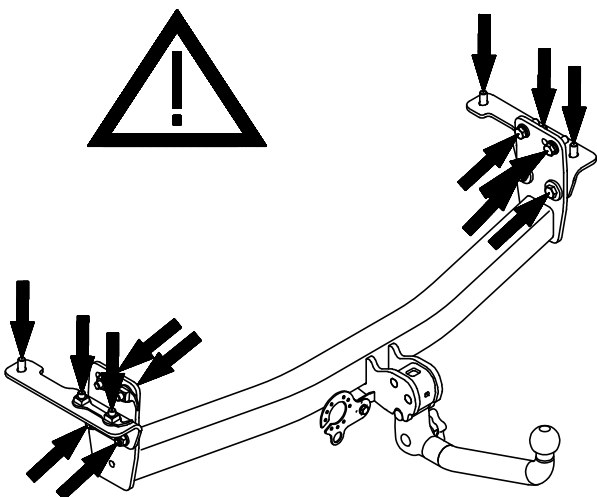
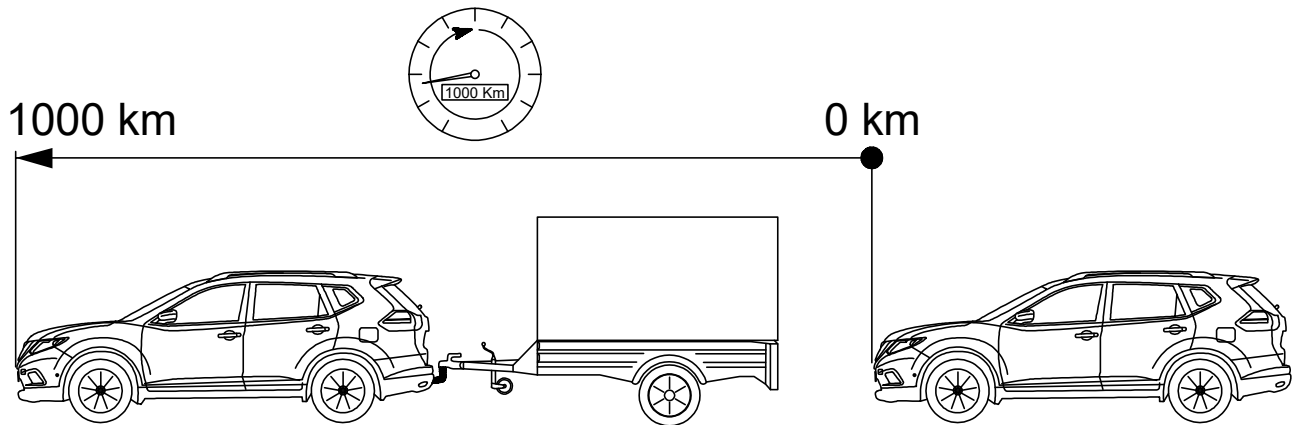
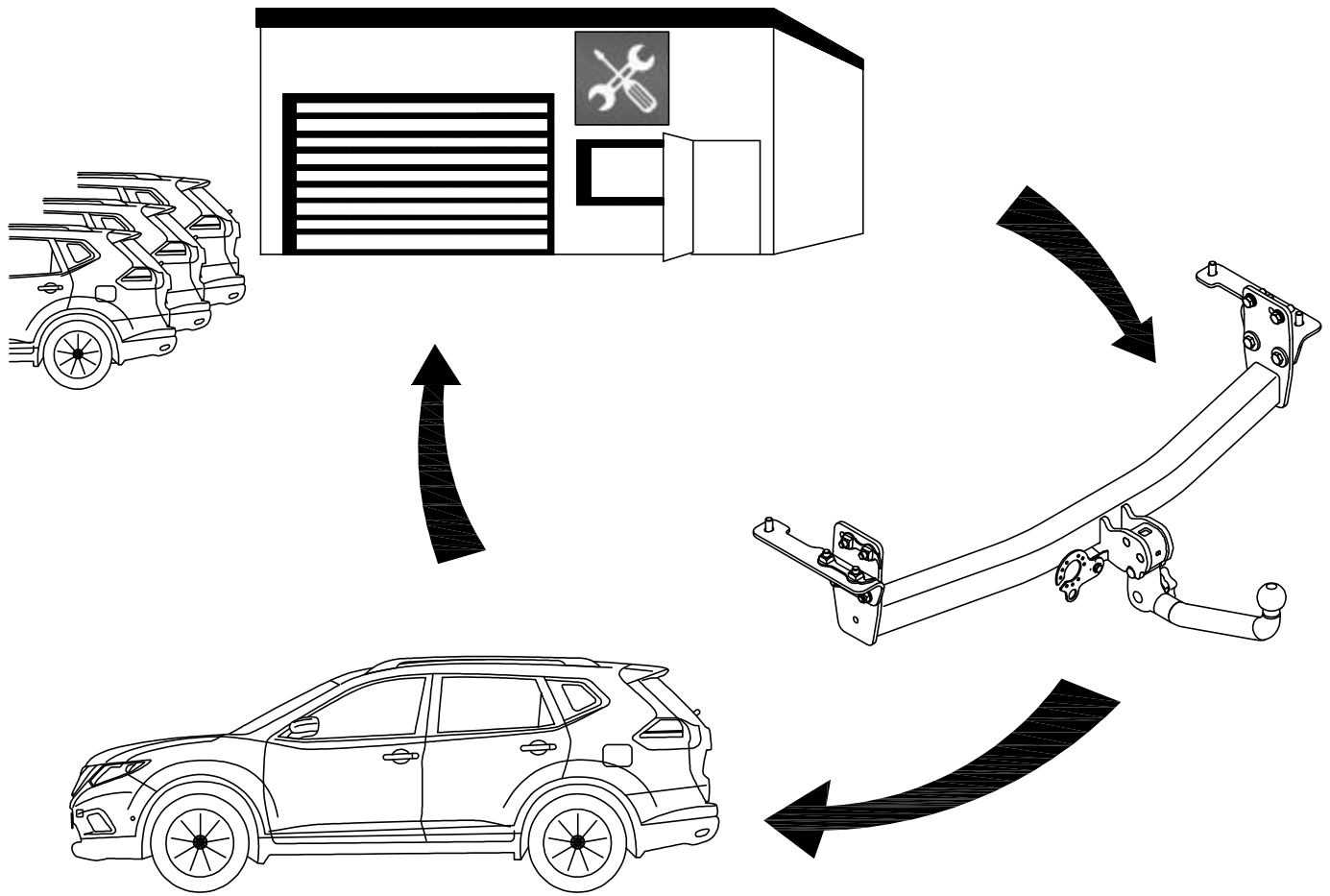

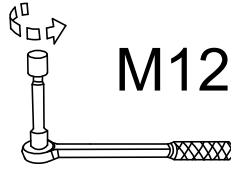
	<p>M12</p> <p>68 Nm</p>
--	-------------------------

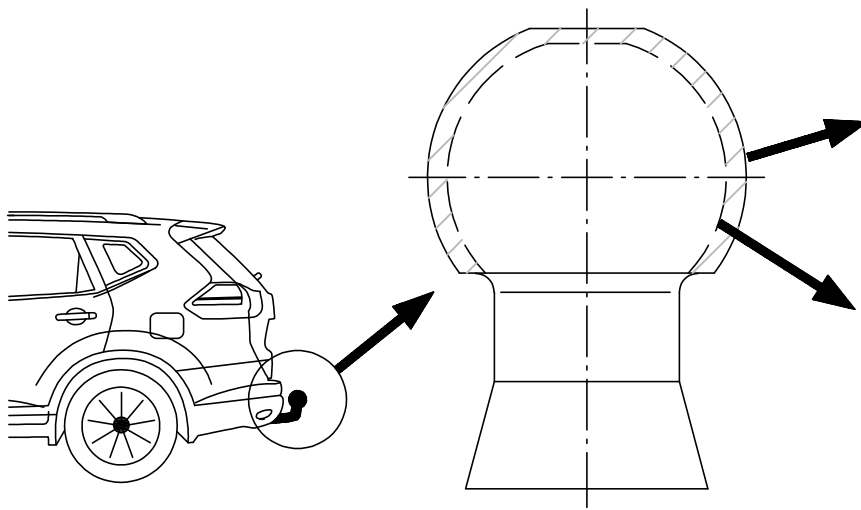

Ø = 50 mm



Ø < 49 mm



Approval Number



55R-01 0967

Type: 2723 C D-Value: 10,8 kN

Class: A50-X S-Value: 120 kg

Made in Germany

www.mvg-ahk.de

Zulässige Stützlast maximal 75 kg



www.mvg-ahk.de



Zulässige Stützlast maximal 100 kg



www.mvg-ahk.de

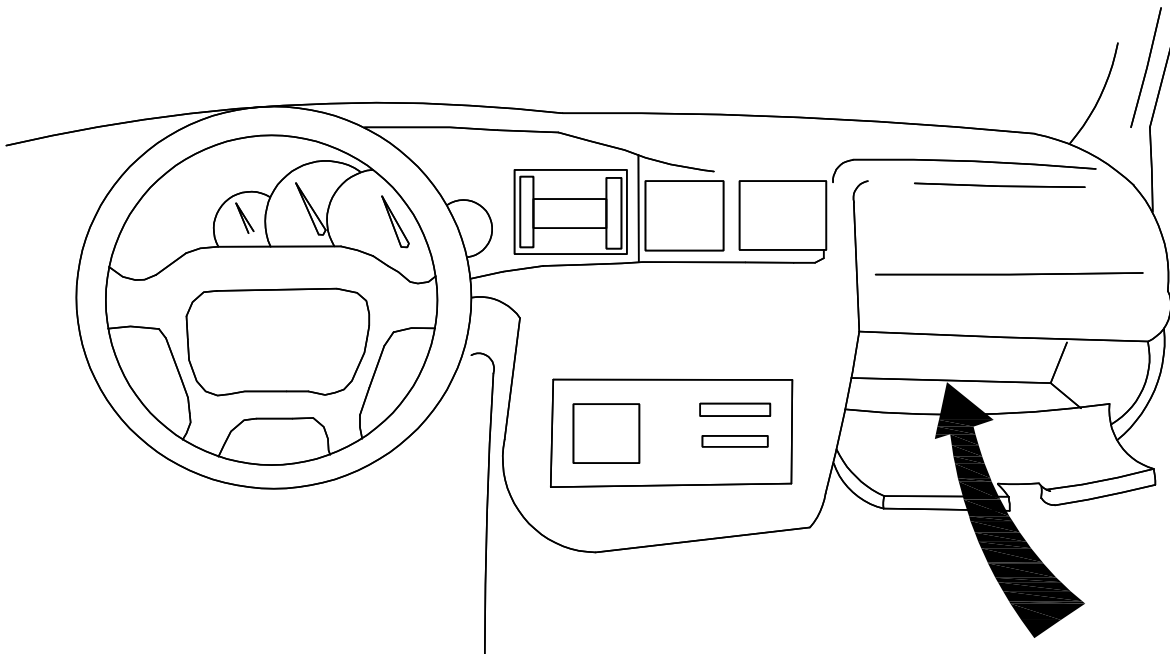

Technische Änderungen vorbehalten

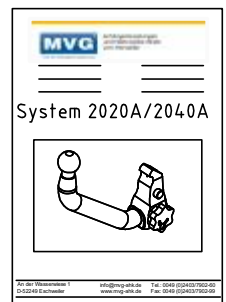
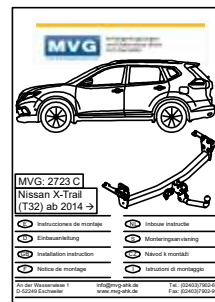

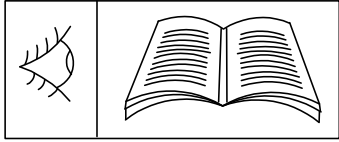

siehe Werkstatthandbuch

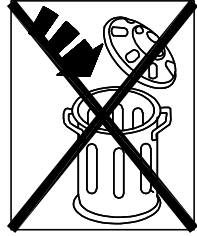

Nicht Entsorgen

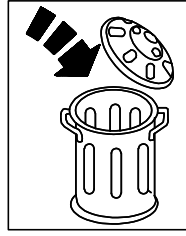

Entsorgen

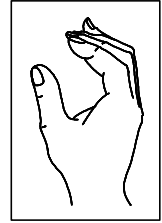

Von Hand



Achtung

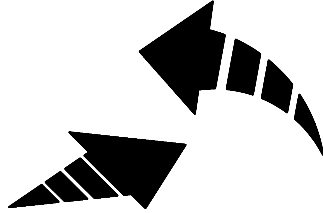

Bewegungspfeil



Positionspfeil

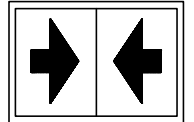
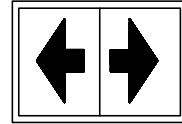

Stecker lösen/ verbinden

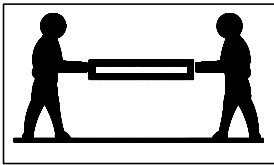

Nur zu zweit ausführen

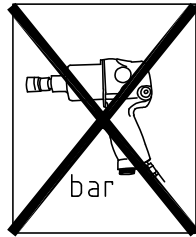

Ohne Druckluft

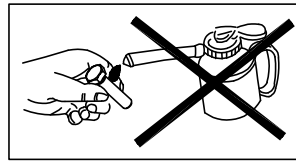

Nicht ölen

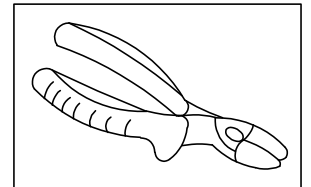

Seitenschneider verwenden

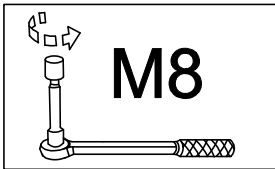

Festdrehen

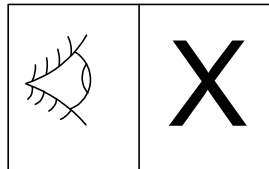

Siehe Abbildung



**CLEANER**

Reinigen

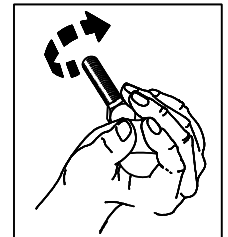

Von Hand festdrehen

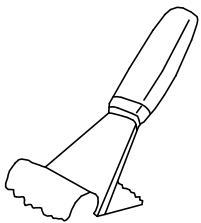

Unterbodenschutz entfernen



Gegen Korrosion schützen

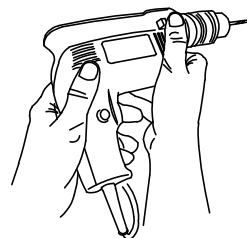

Bohrer verwenden

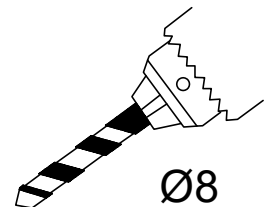

Bohrer Ø X wählen

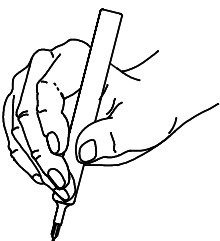

Anzeichnen

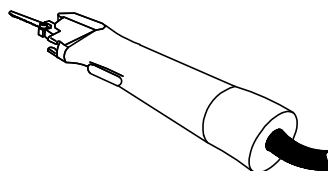



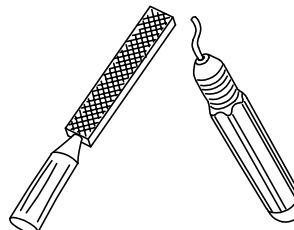



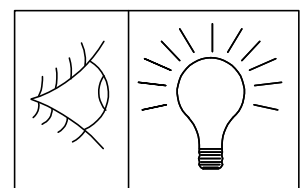





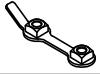

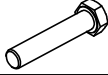







Schneiden



Feilen/ Entgraten



Licht kontrollieren

1	1x		2723 C		
2	1x		2040 A 020		
3	je 1x		(links & rechts)		
4	1x				
5	1x				
6	6x		M12x1,25x35 (8.8)	ISO 8676	
7	8x		M12x35 (8.8)	ISO 4017	
8	6x		B12	DIN 127	
9	10x		Ø13/ 35x5	ISO 6340	
10	8x		Ø13/ 24x2,5	ISO 7089	
11	4x		M12 (10)	ISO 7042	
12	1x				
13	1x		M8x45 (8.8)	ISO 4017	
14	1x		Ø8,4/ 16x1,6	ISO 7089	
15	1x				
16	1x				
17	2x		Ø8,4/ 16x1,6	DIN 125 PA 6.6	
18	1x		M8 (8)	ISO 7042	
19	1x		2723 C		
20	1x		System 2020 A / 2040 A		
21	je 1x		75kg; 100kg	1016	
22	1x			0062	
23	1x			1012	
24	2x				

**E** Volumen de suministro del enganche

**D** Lieferumfang der Anhängervorrichtung

**GB** Scope of delivery of towing hitch

**F** Pièces comprises dans la fourniture de l'attelage

**NL** Leveringsomvang trekhaak

**S** Dragkrokens leveransspecifikation

**CZ** Objem dodání tažného zařízení

**I** Dotazione del gancio di traino

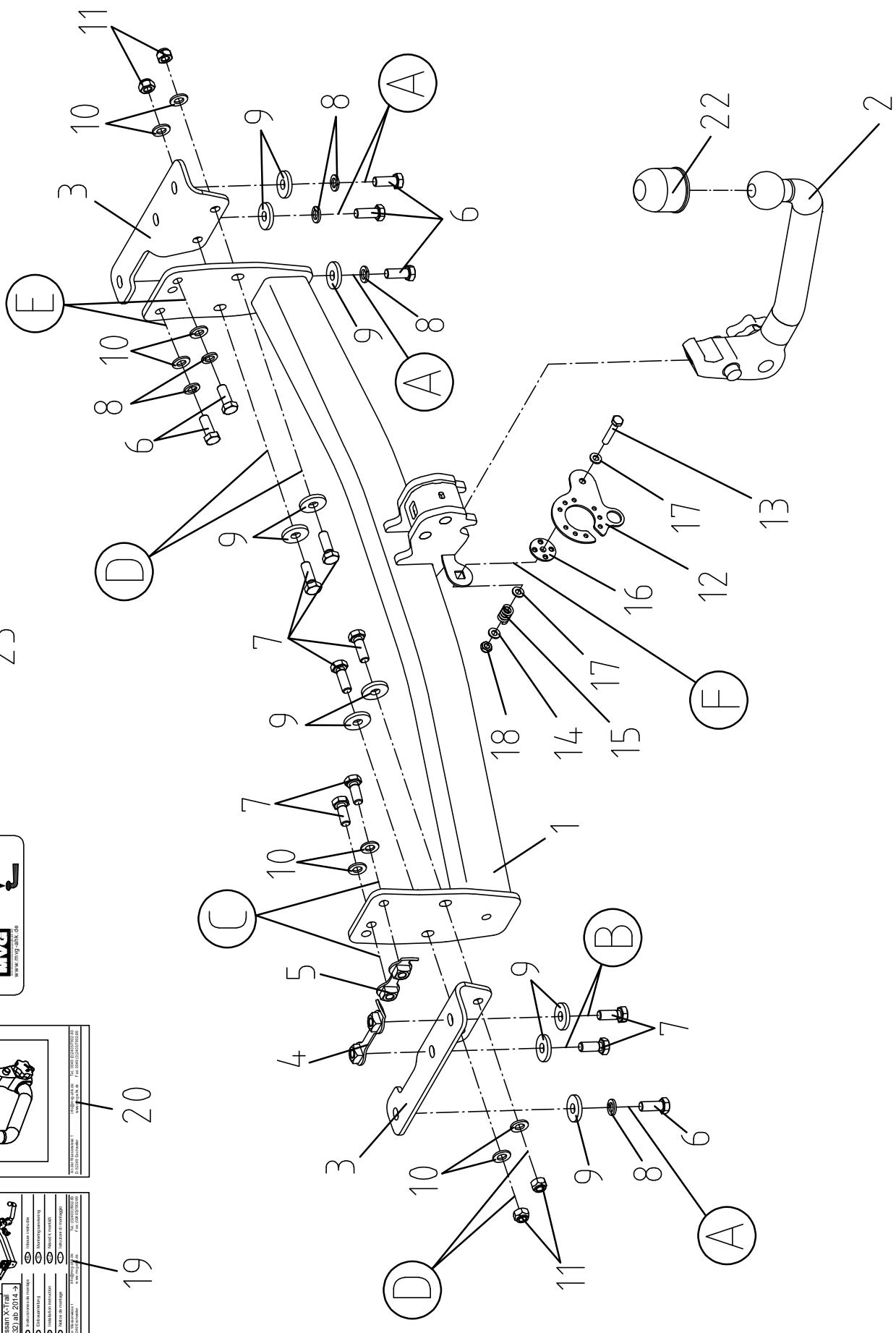
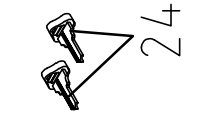
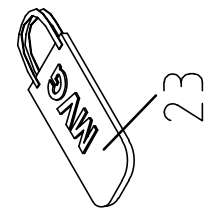
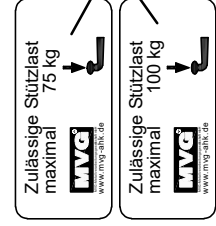
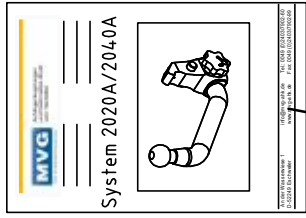
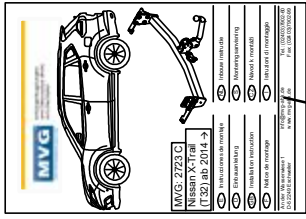

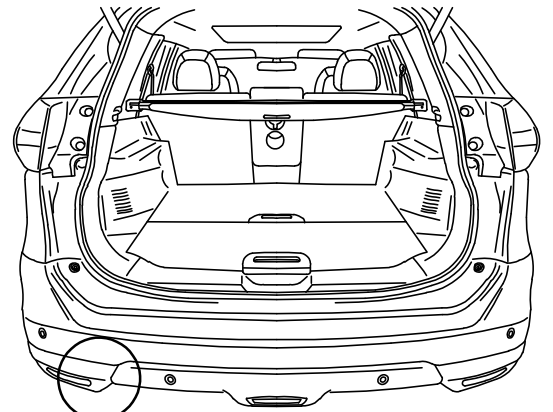
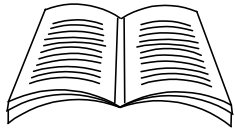

X1

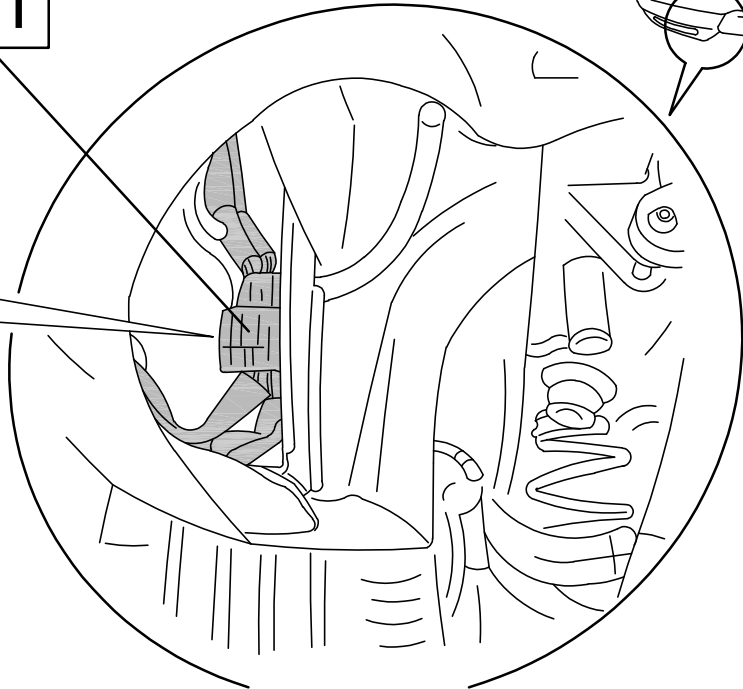
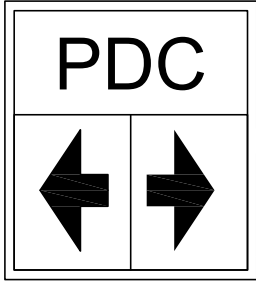

2

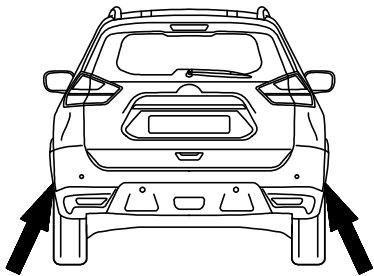

"STOP"

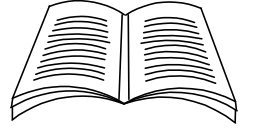

X2

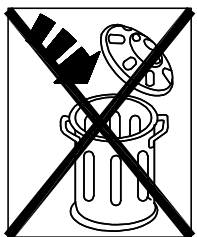
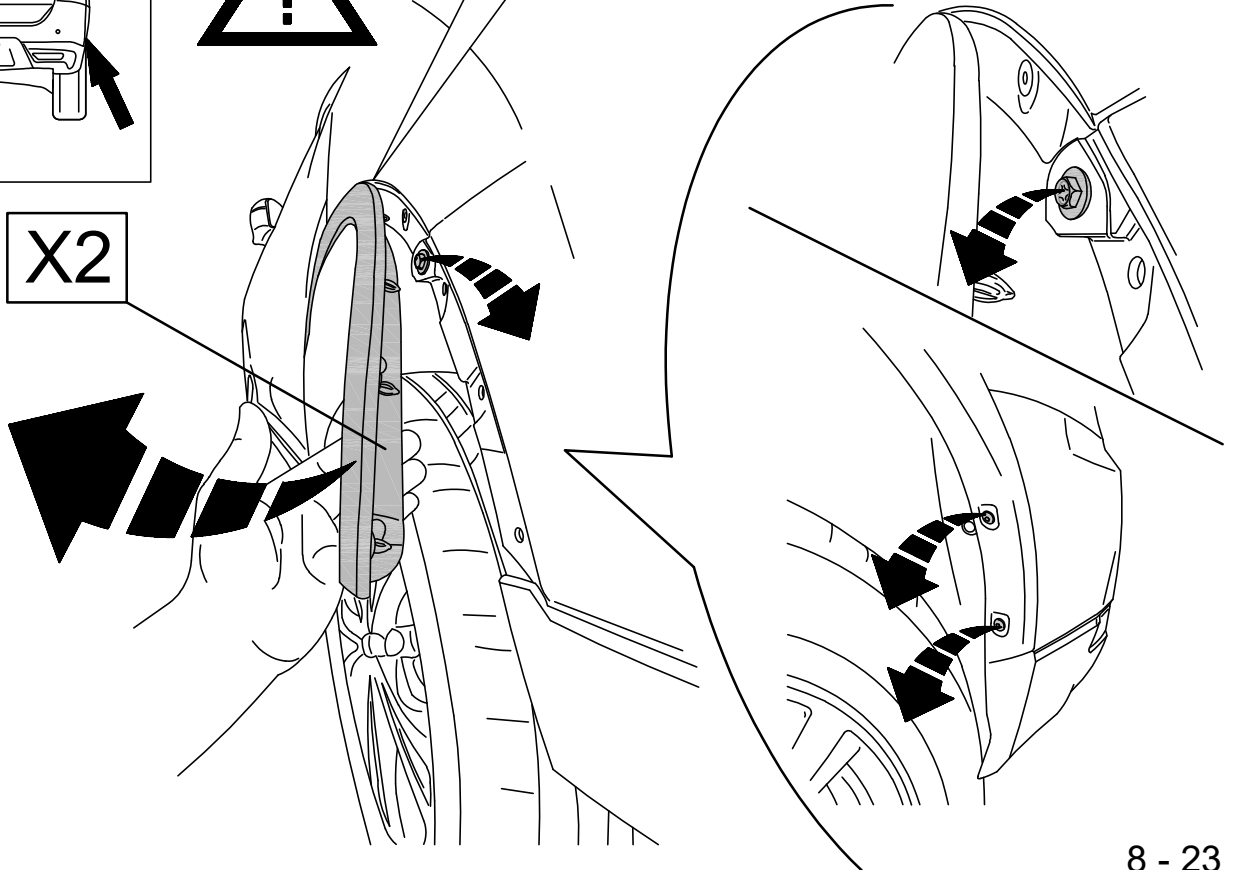

3



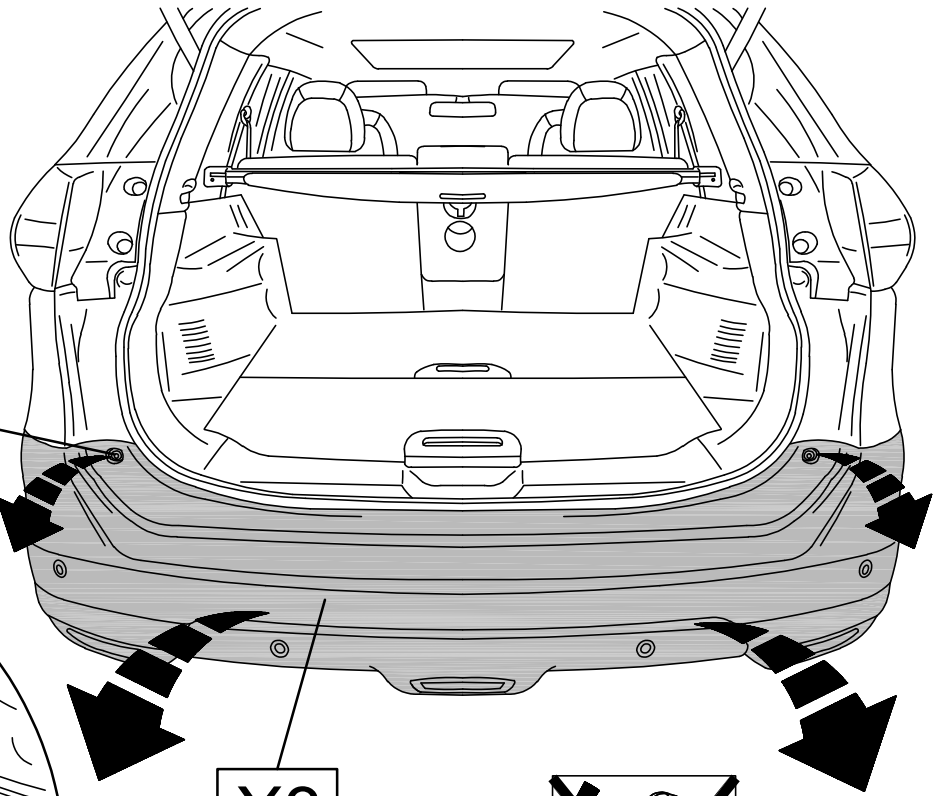
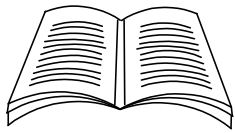

X4

X3

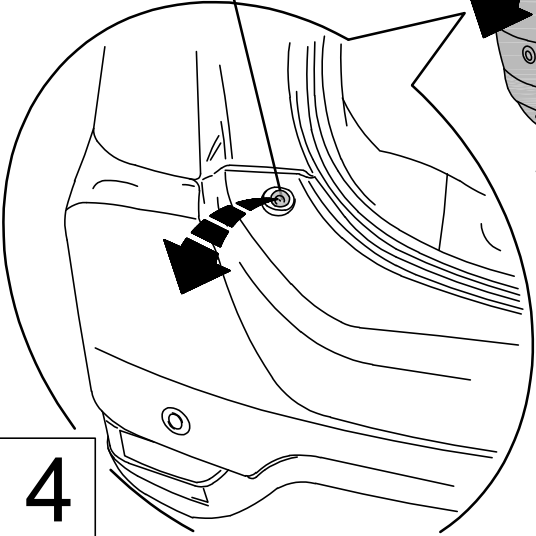
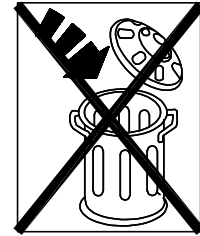

4

Ab 2014 →

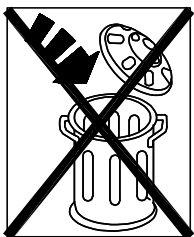
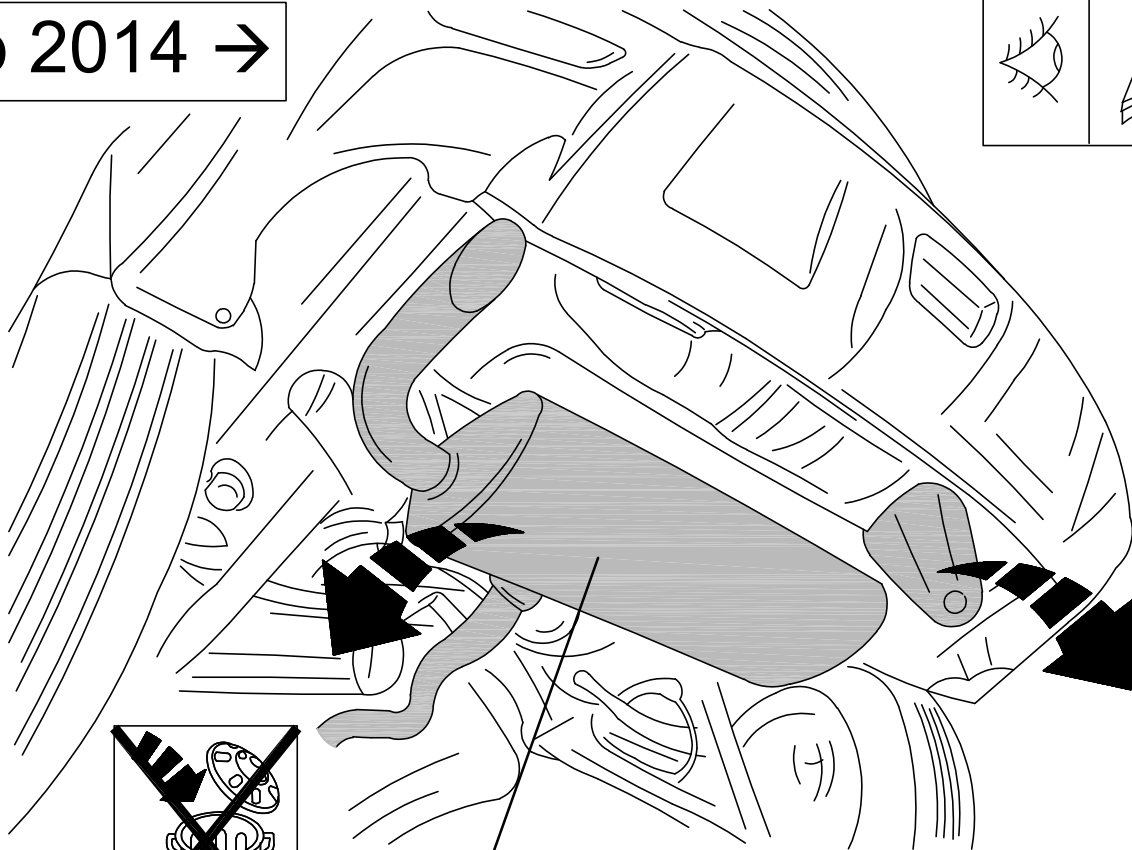
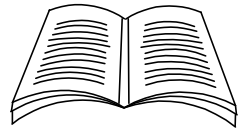

X4

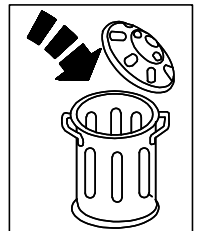

5

Ab 2017 →

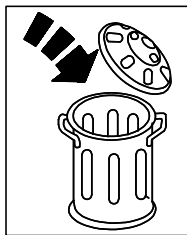
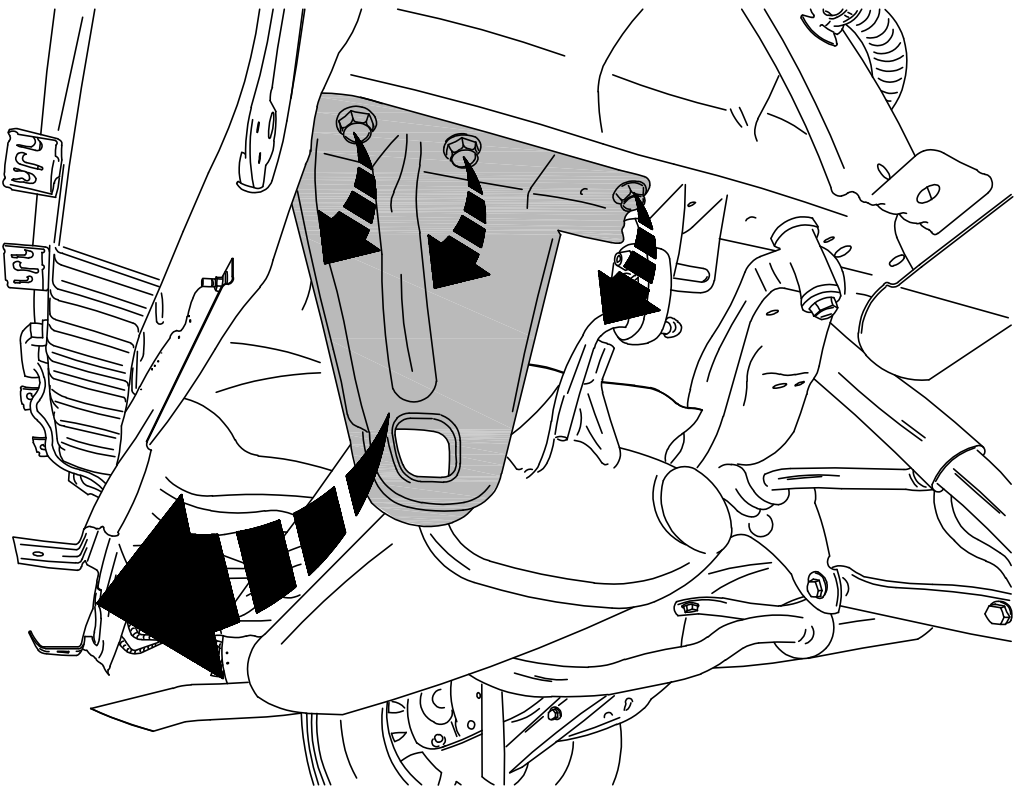
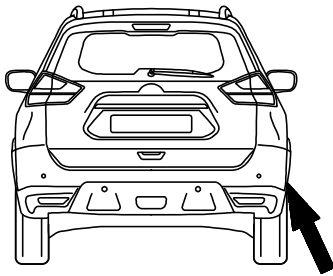

6

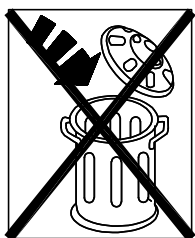
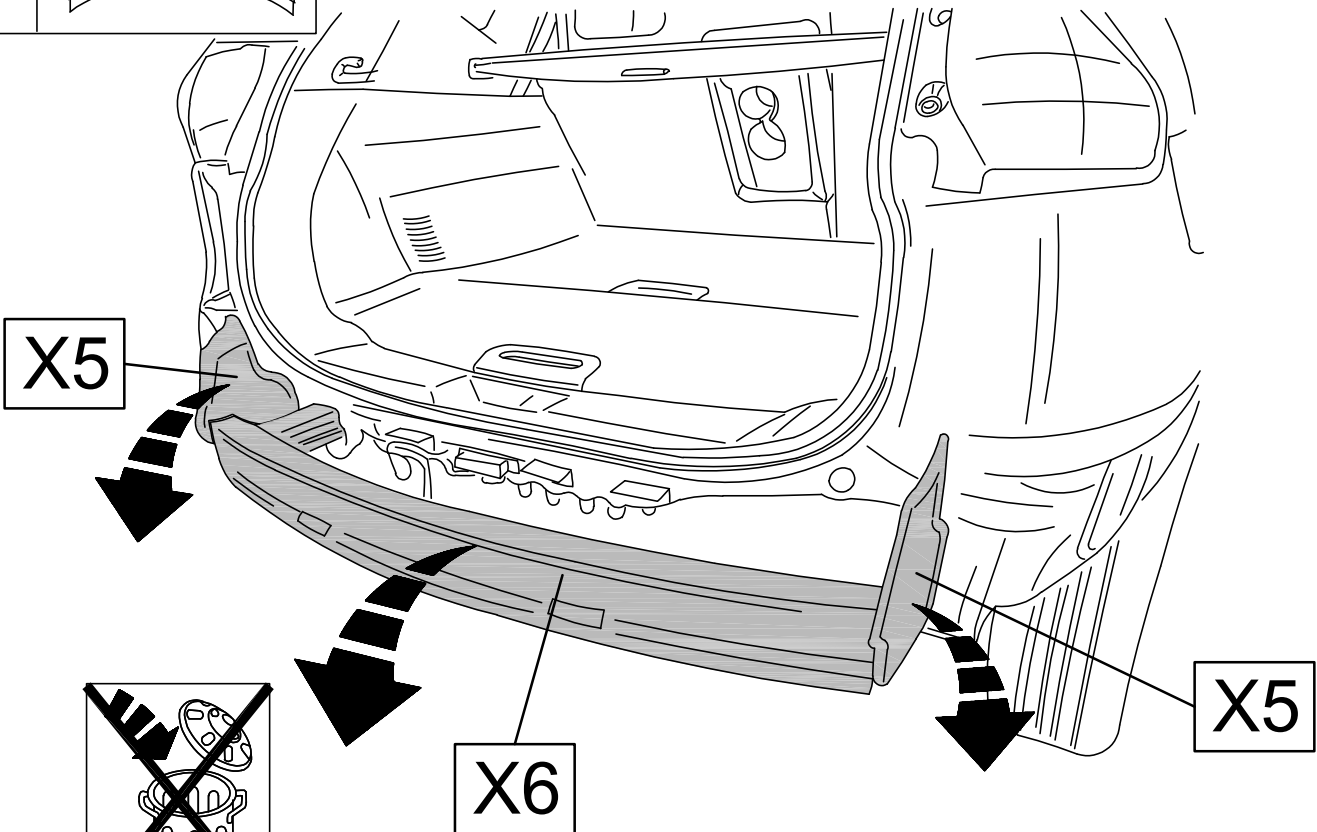

7

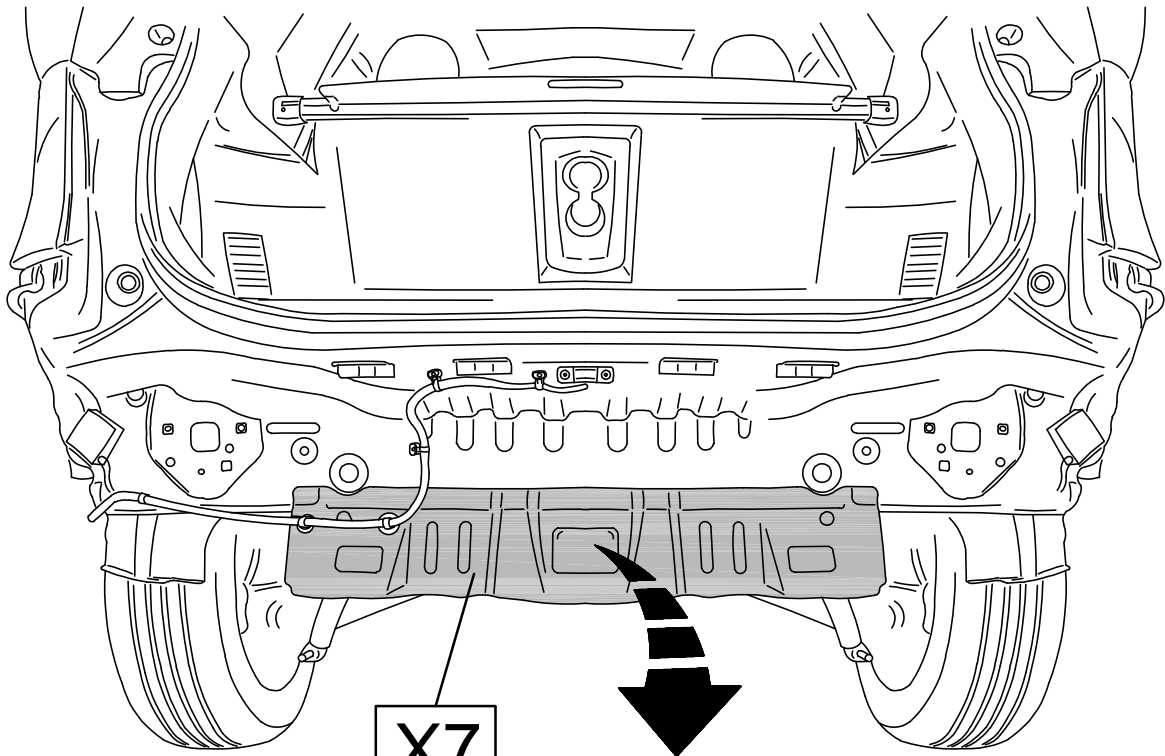

X7

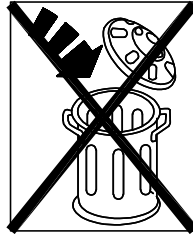

8

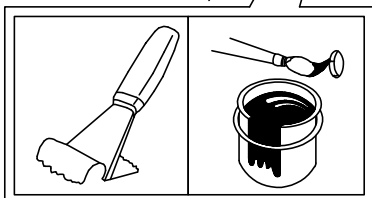
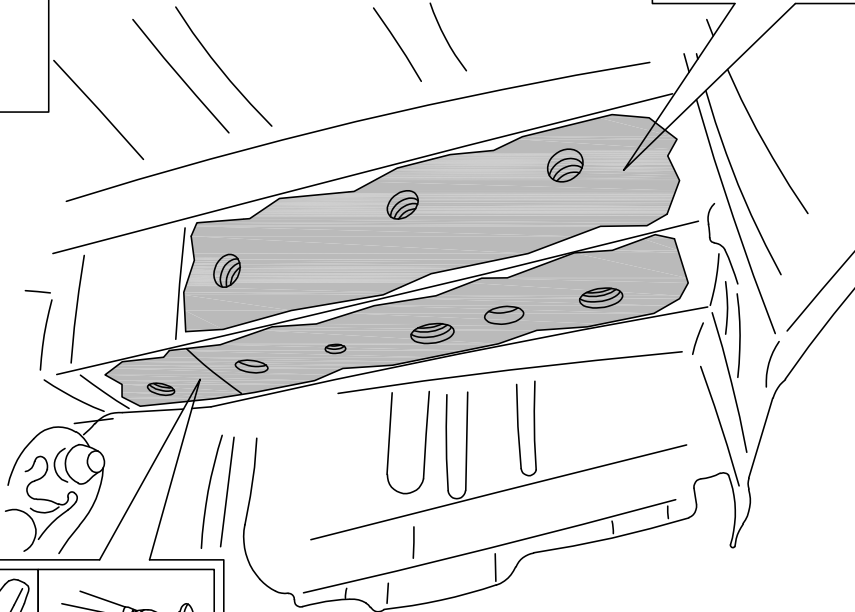
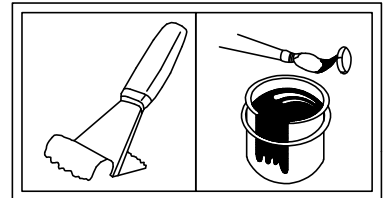
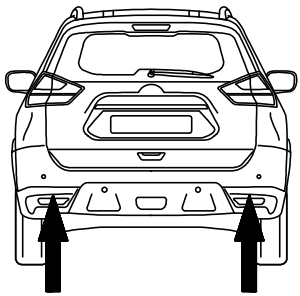

9

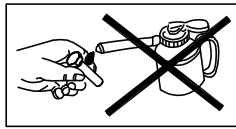
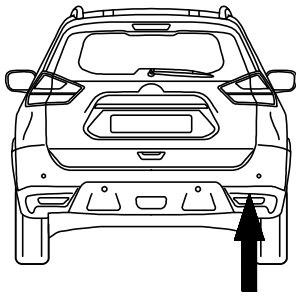

1

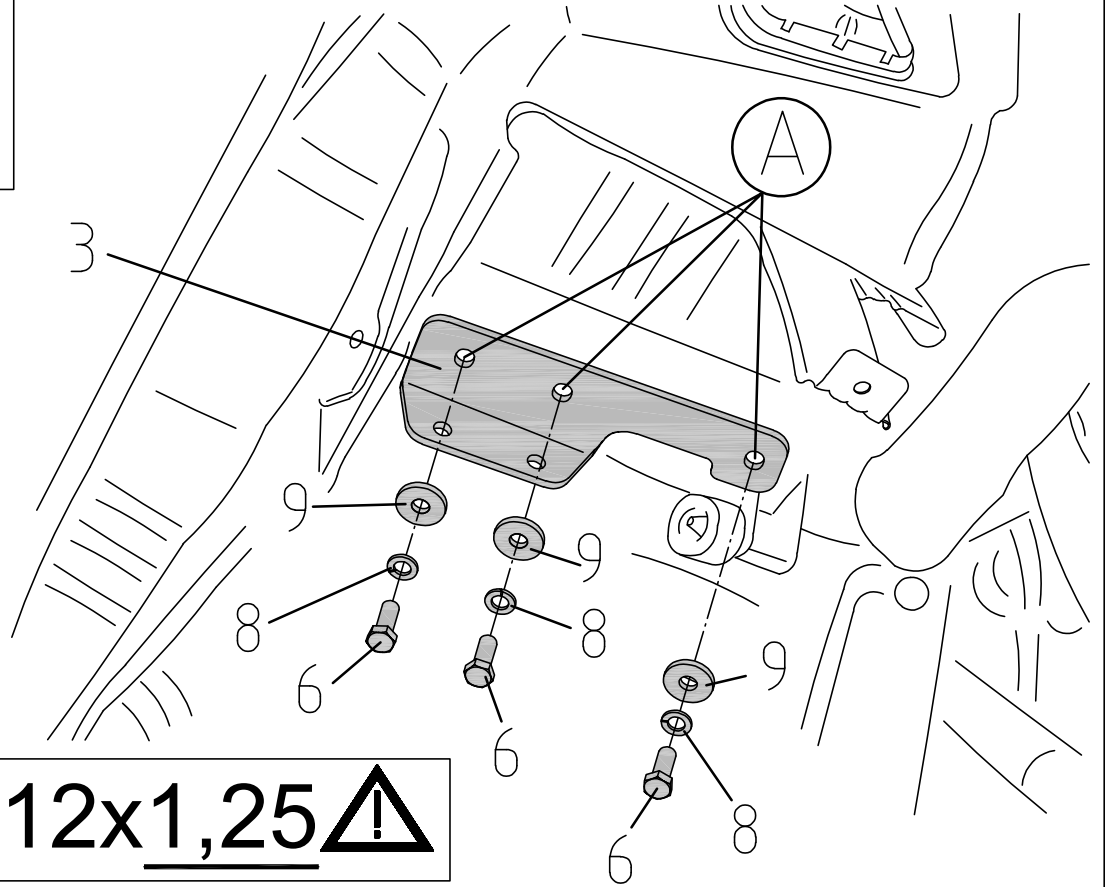
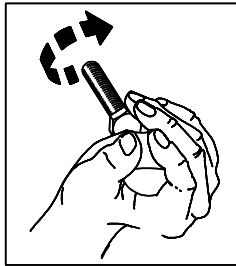
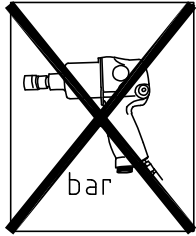

10

**⚠ M12x1,25 ⚠**

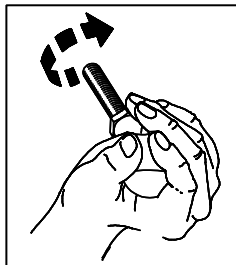
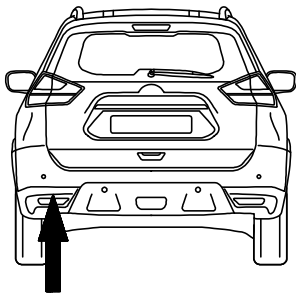

1

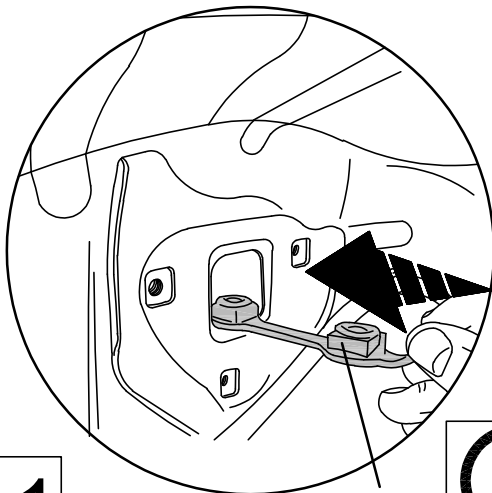
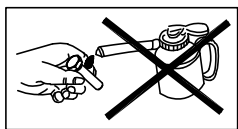

11

**(A) ⚠ M12x1,25 ⚠**



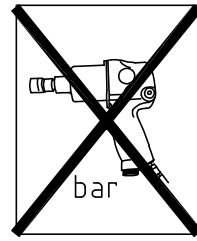
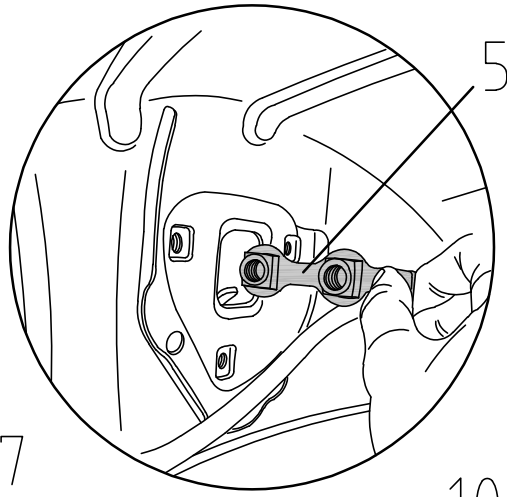
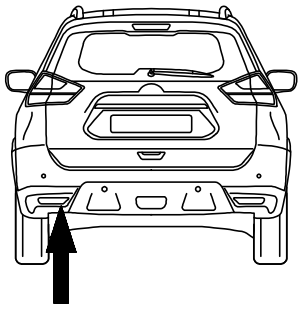

1

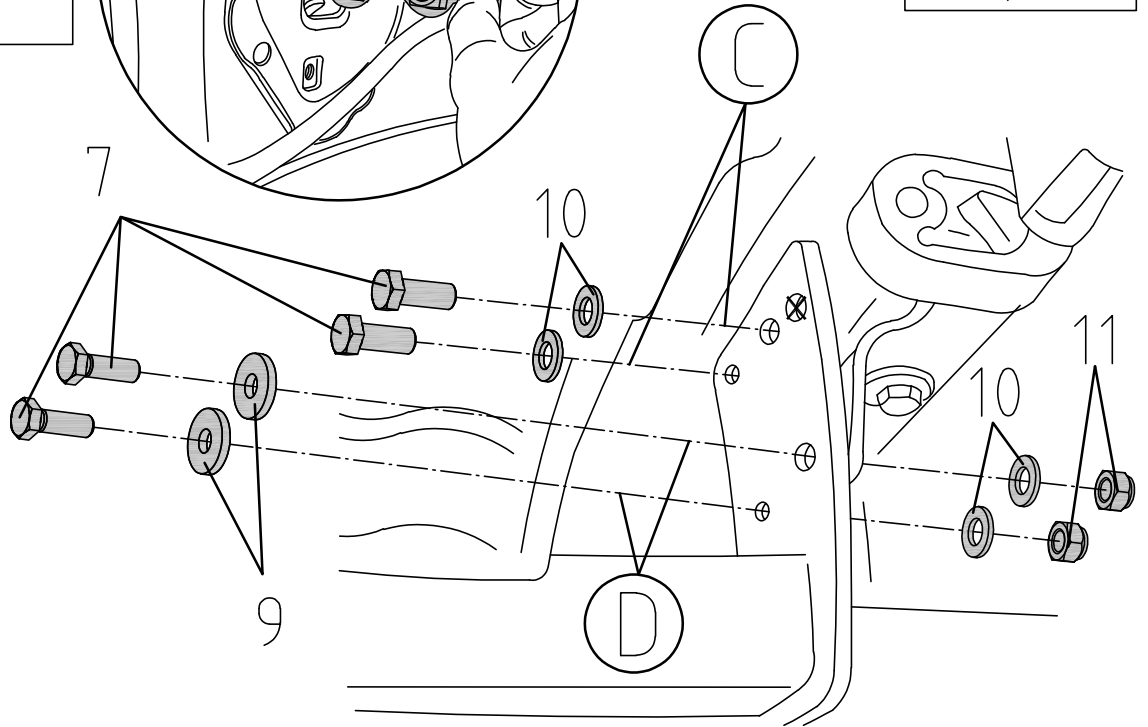
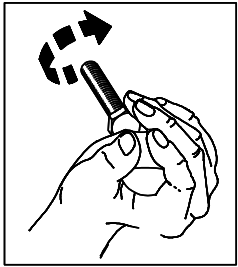
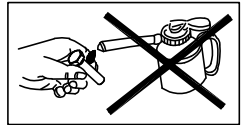

12

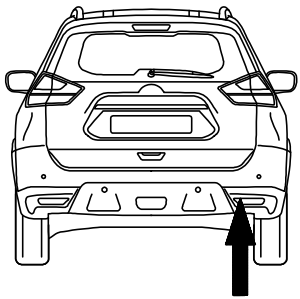

**(E) ⚠ M12x1,25 ⚠**



1

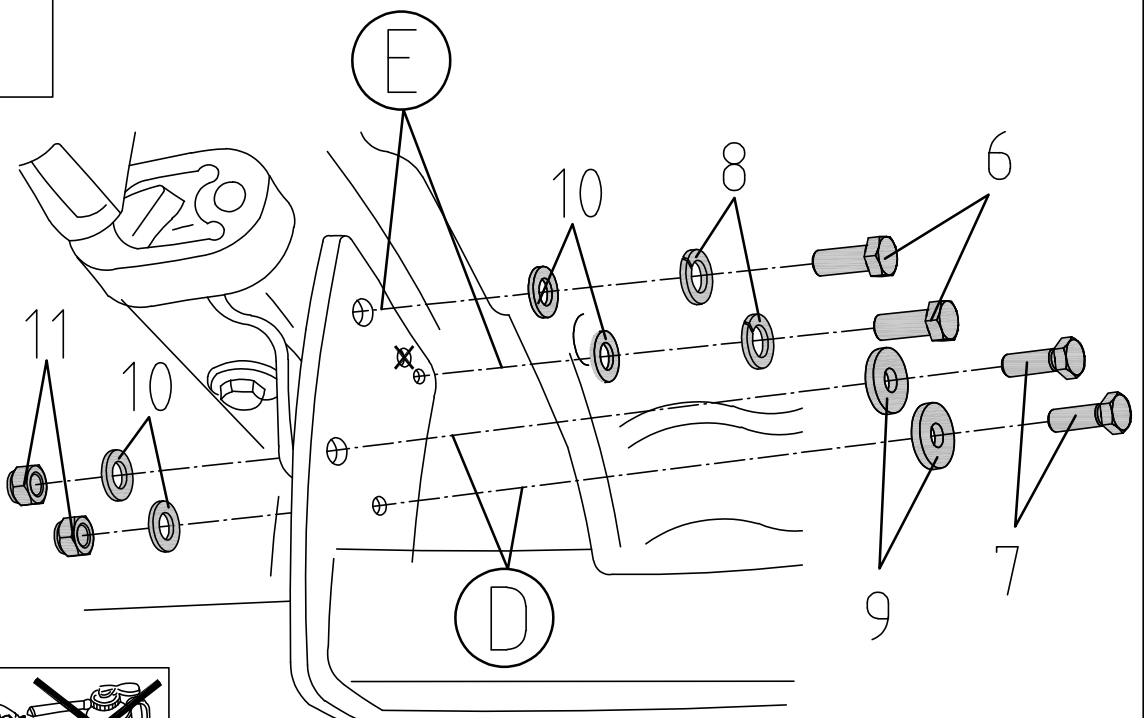
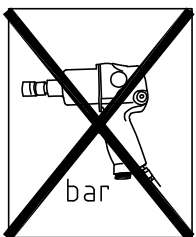
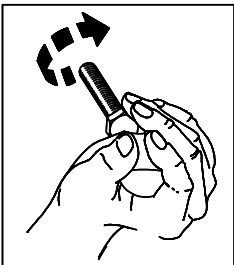

13

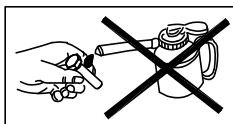

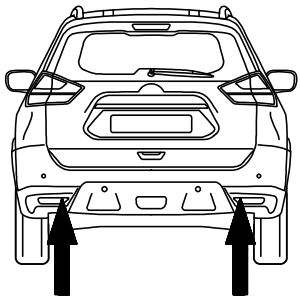

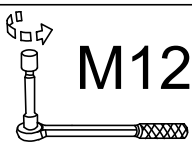
	M12	8.8	68Nm
---	-----	-----	------

1.

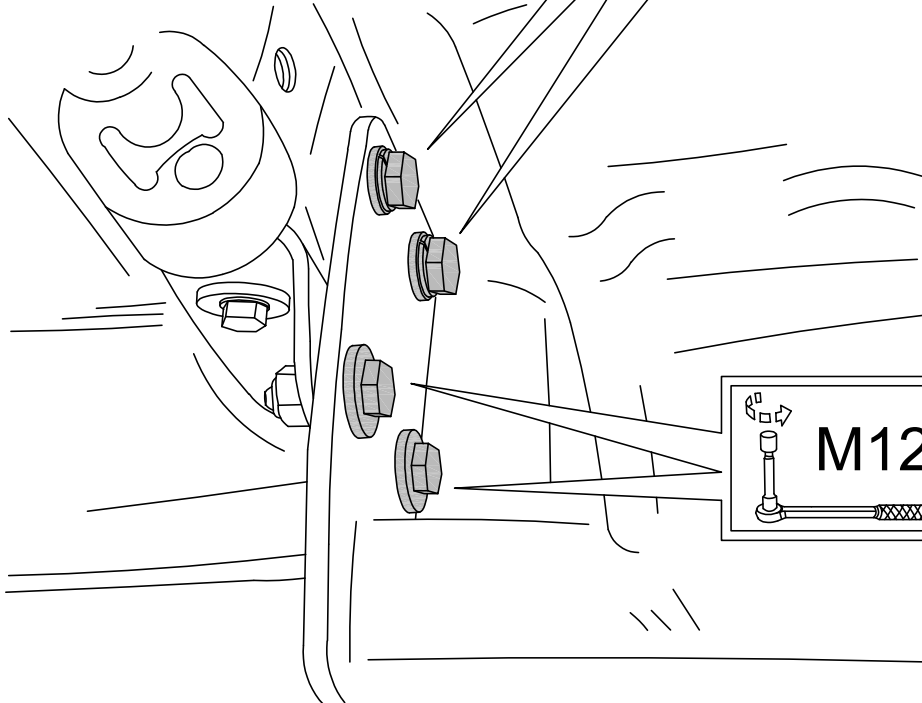
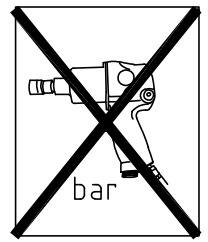

2.

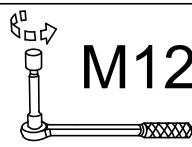
	M12	8.8	68Nm
--	-----	-----	------

14

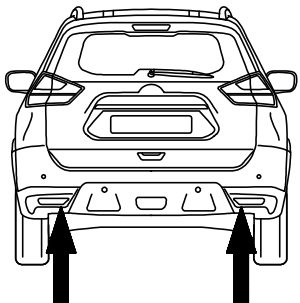

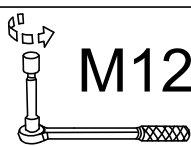
	M12	8.8	68Nm
---	-----	-----	------

3.

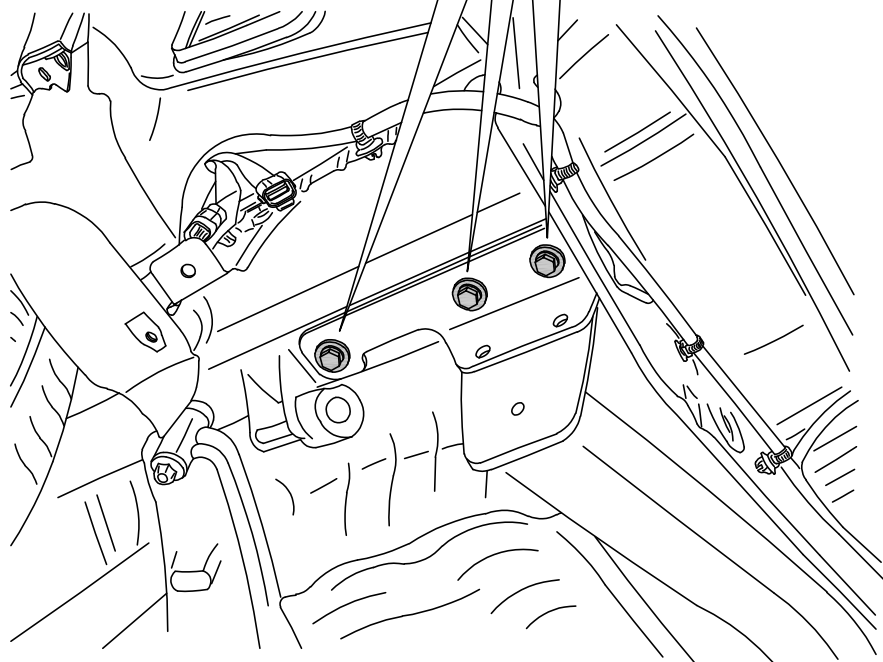
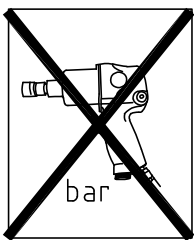

15

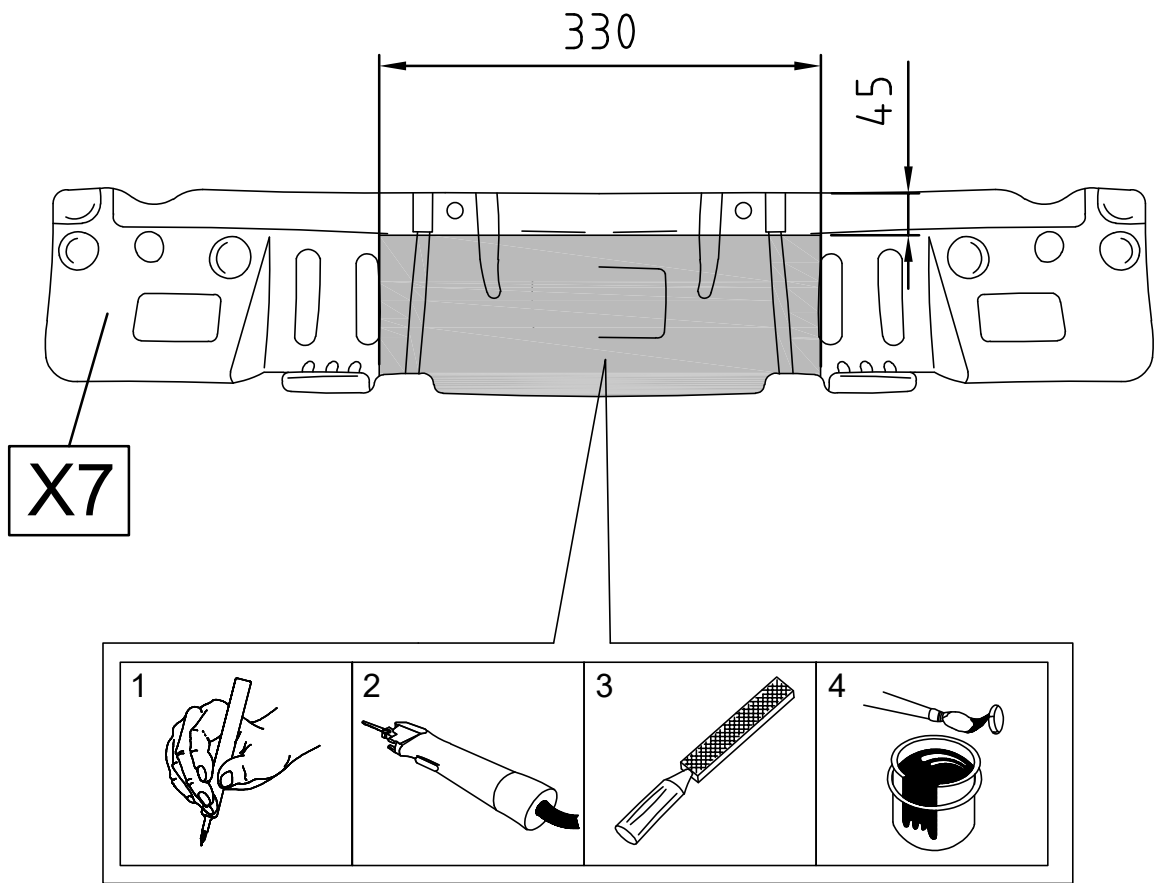

16

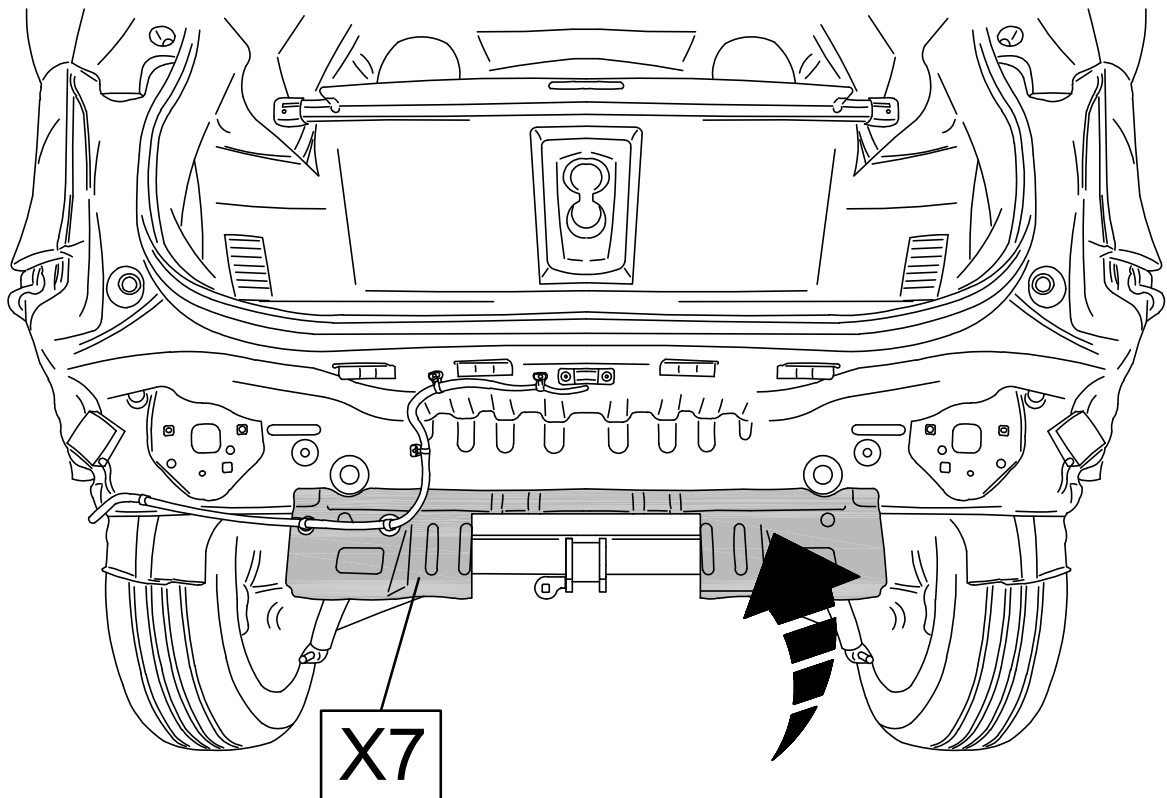

17

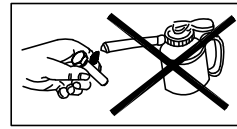
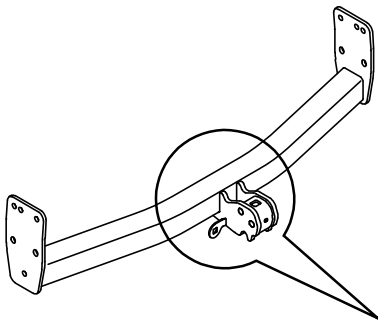

1

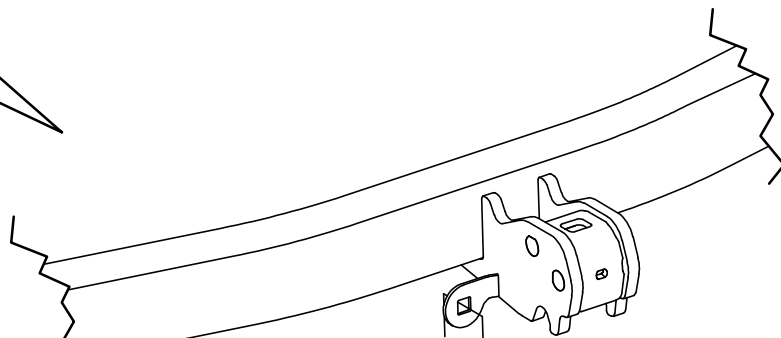
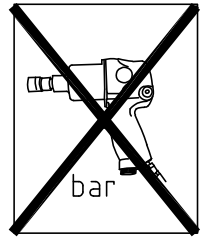

18

14

15

17

16

17

13

12

F

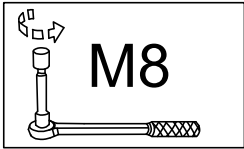

M8

18

X5

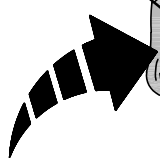

X6



X5

19



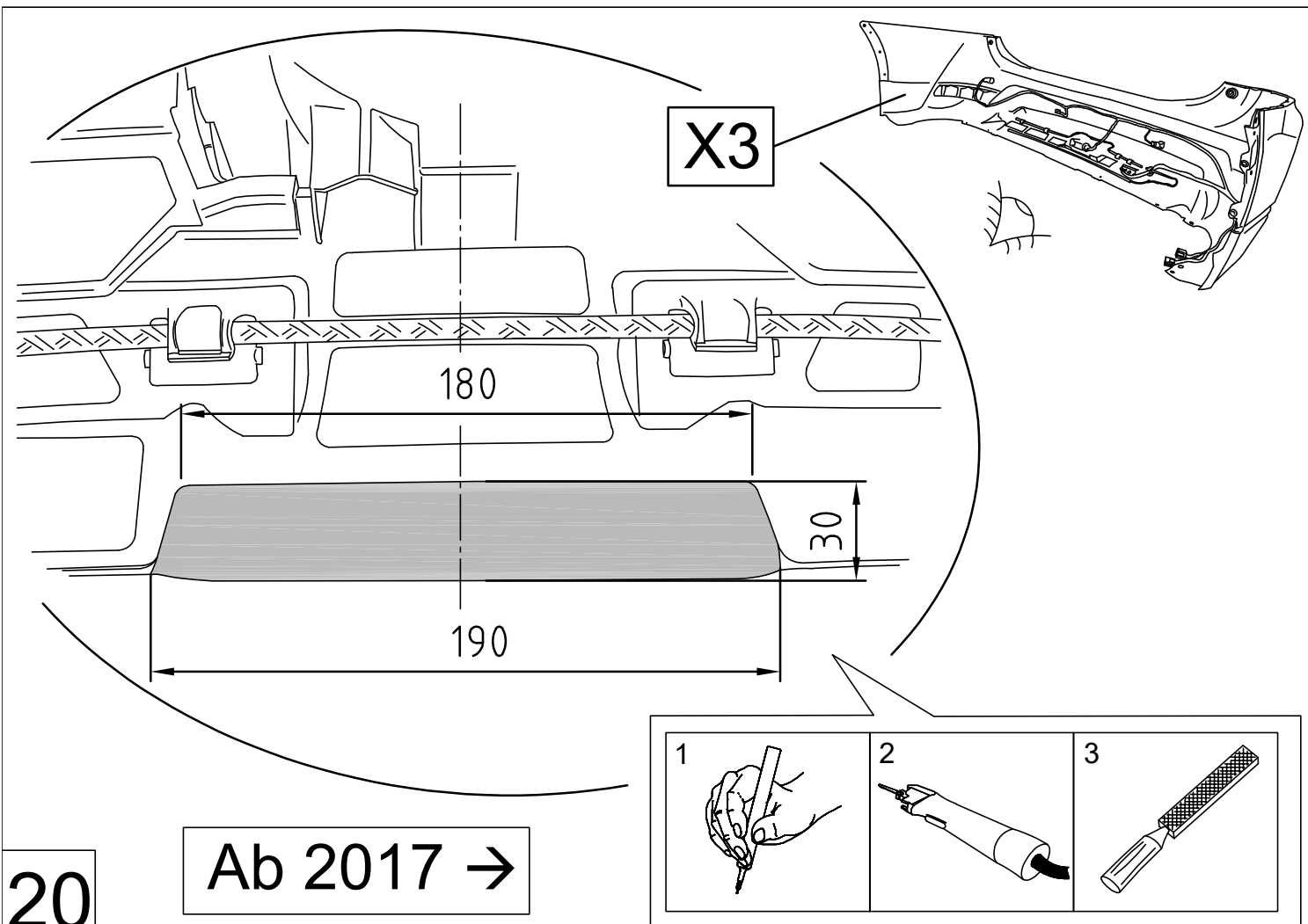

20

Ab 2017 →

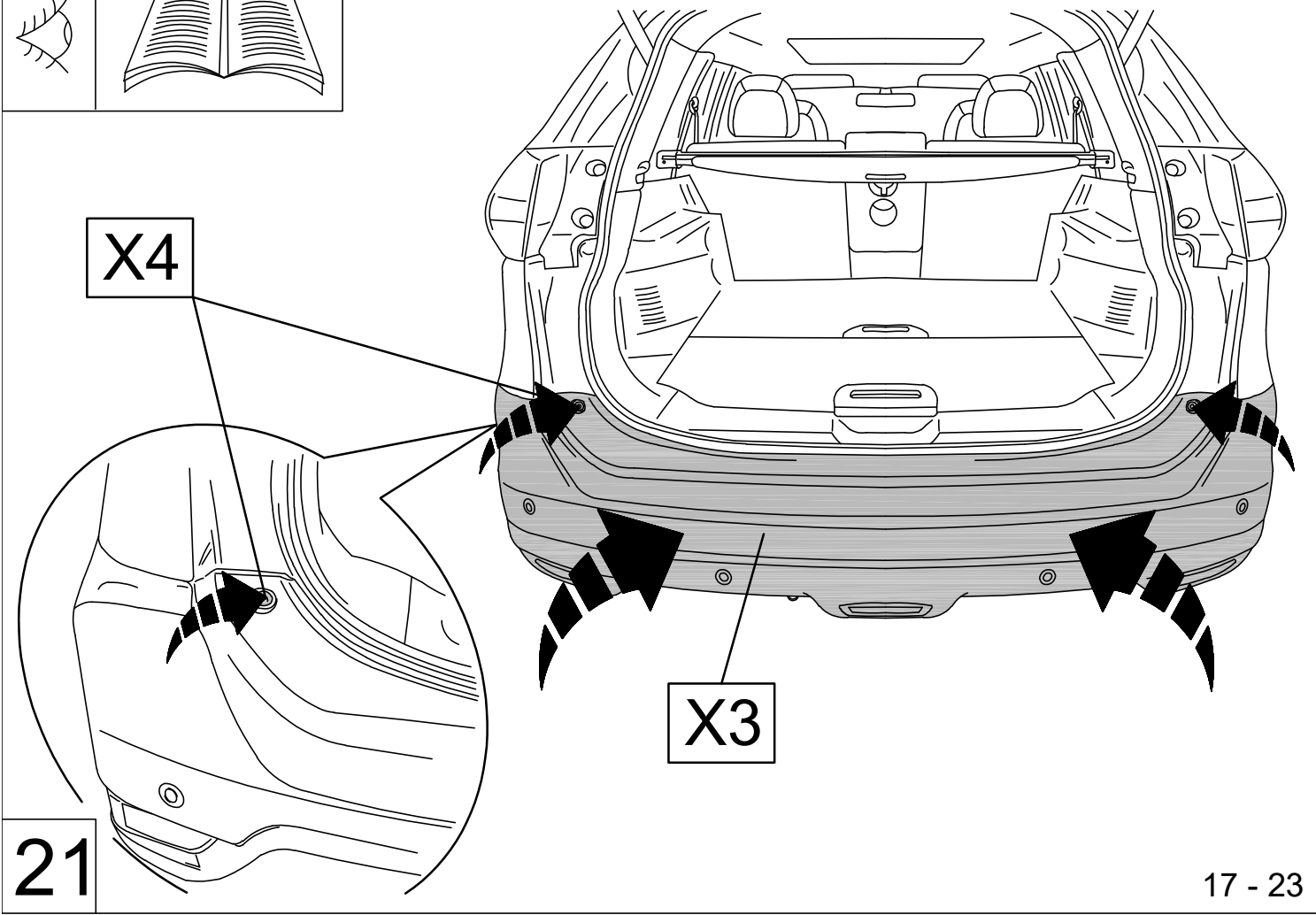
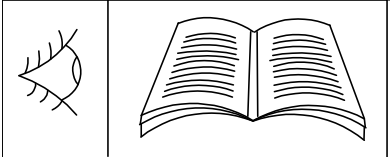

21

Ab 2014 →

X3

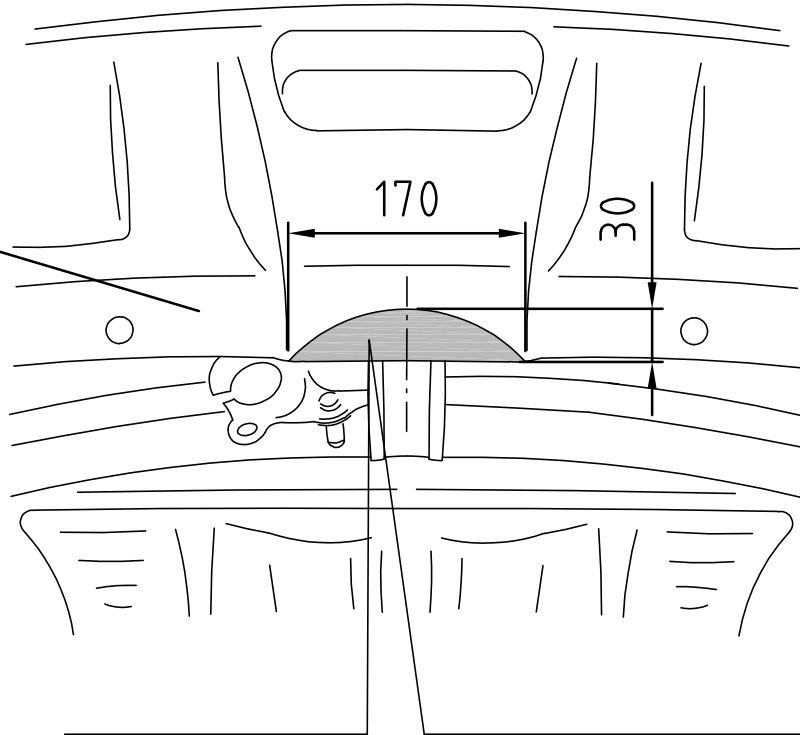

1

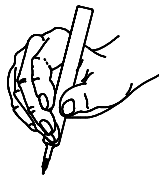

2

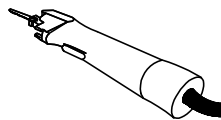

3

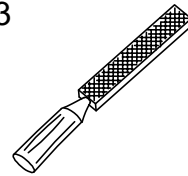

22

Ab 2014 →

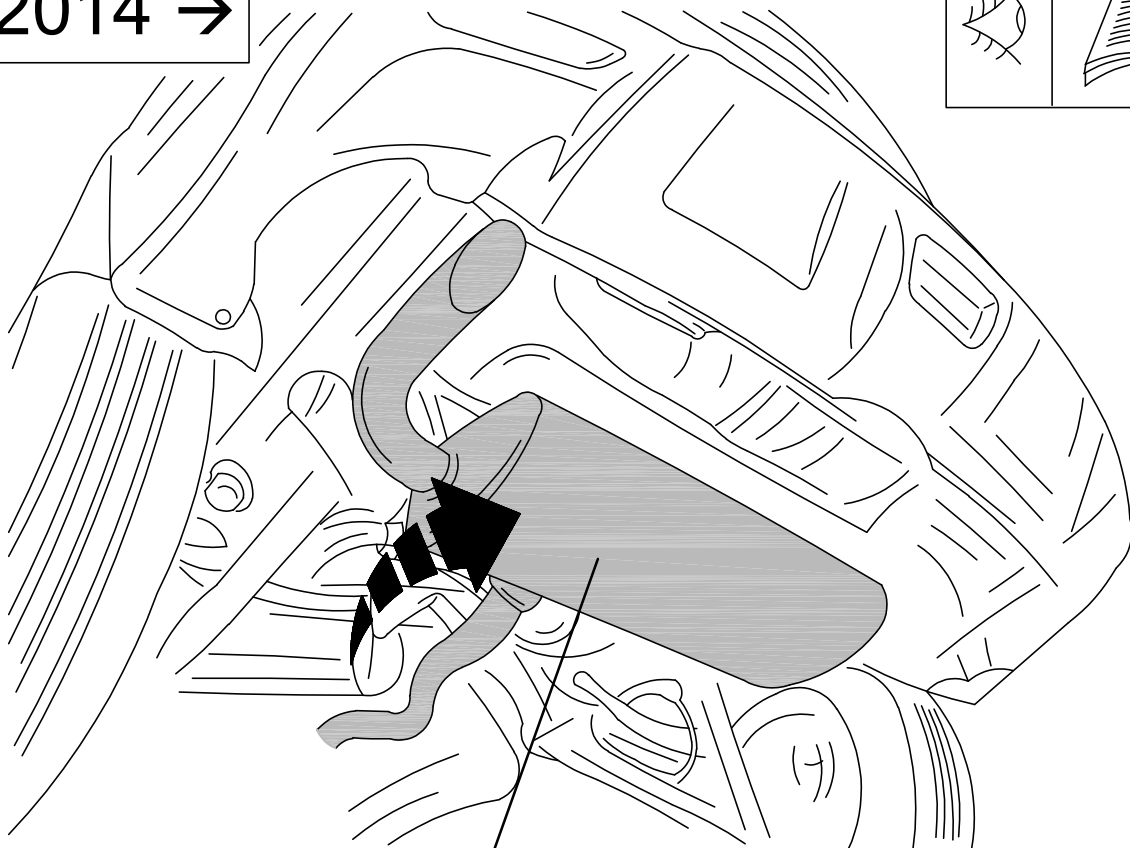

X4

23

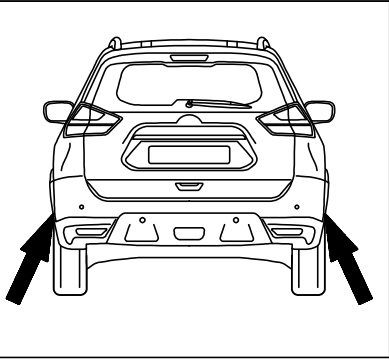

"STOP"

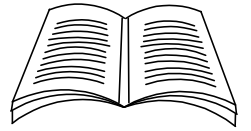

X2



24

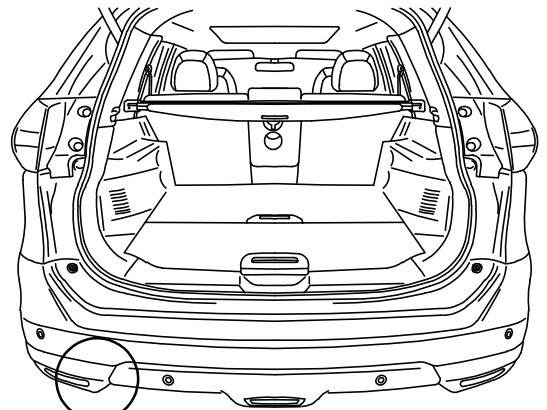
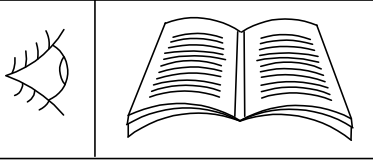

X1

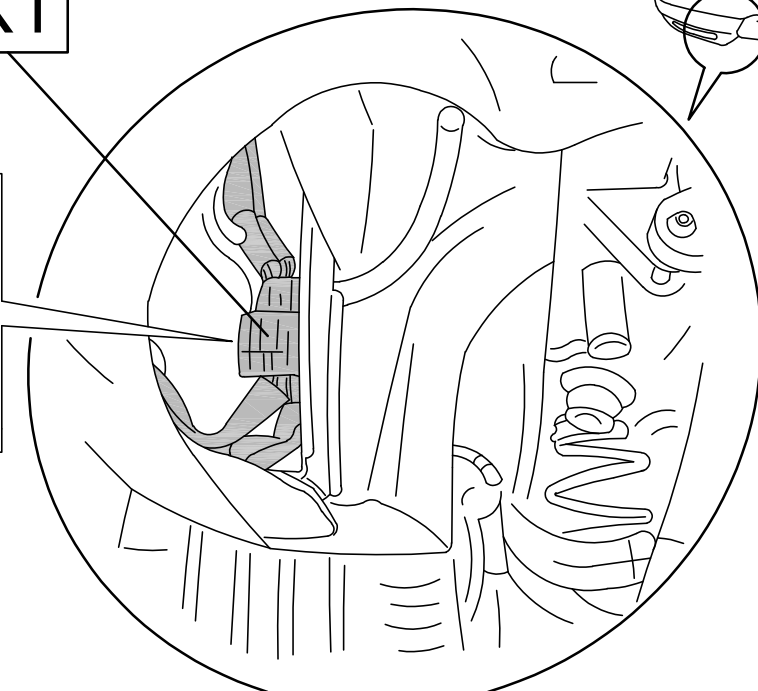
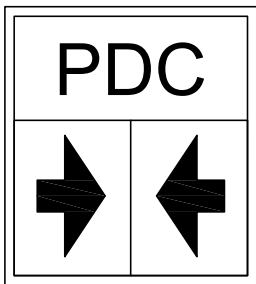

25

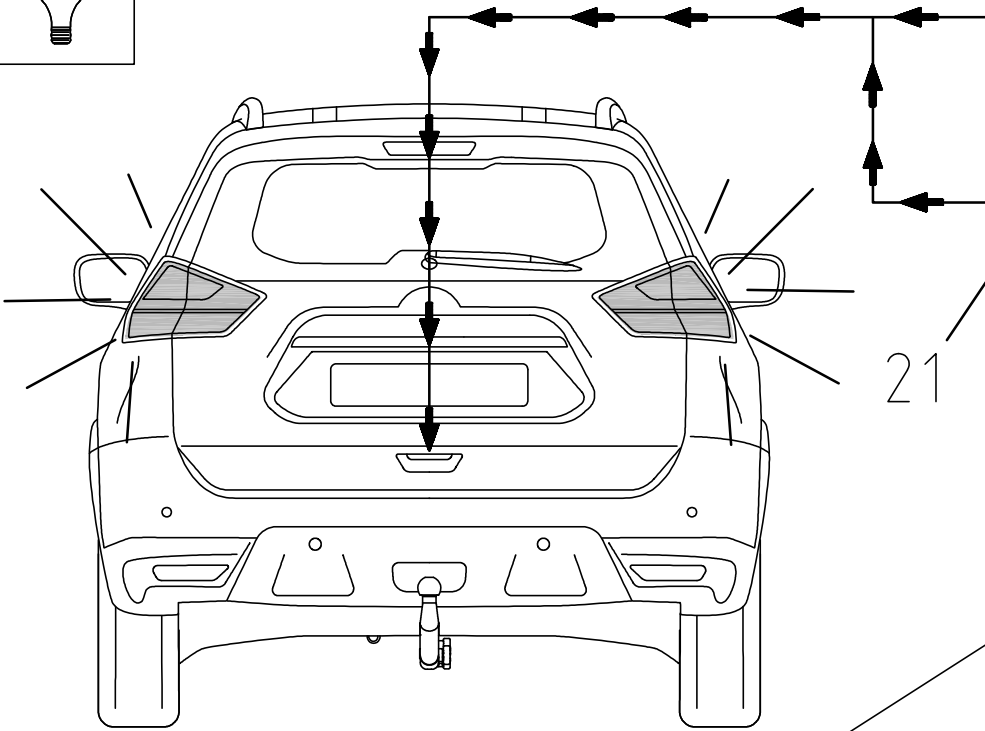
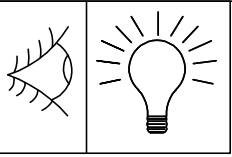

Zulässige Stützlast maximal 75 kg  
MVG  
www.mvg-ahk.de

Zulässige Stützlast maximal 100 kg  
MVG  
www.mvg-ahk.de

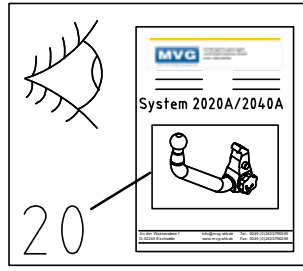

21

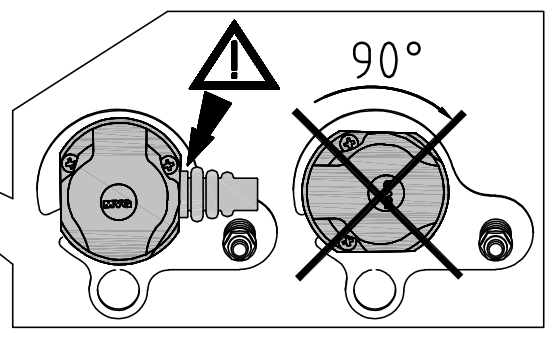

26

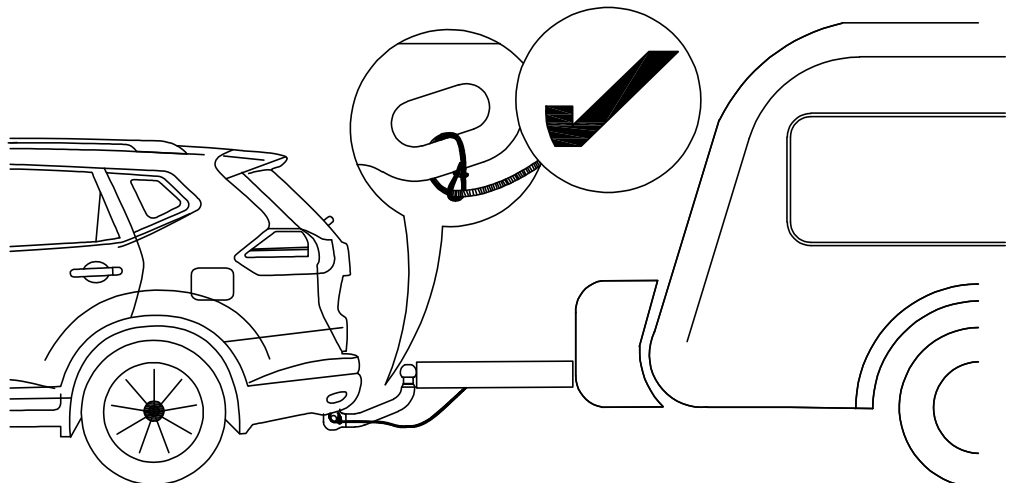
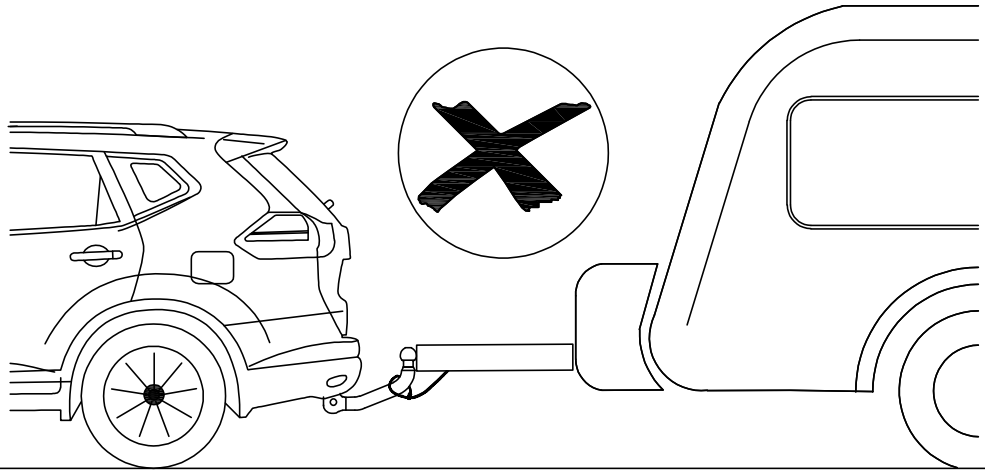

27

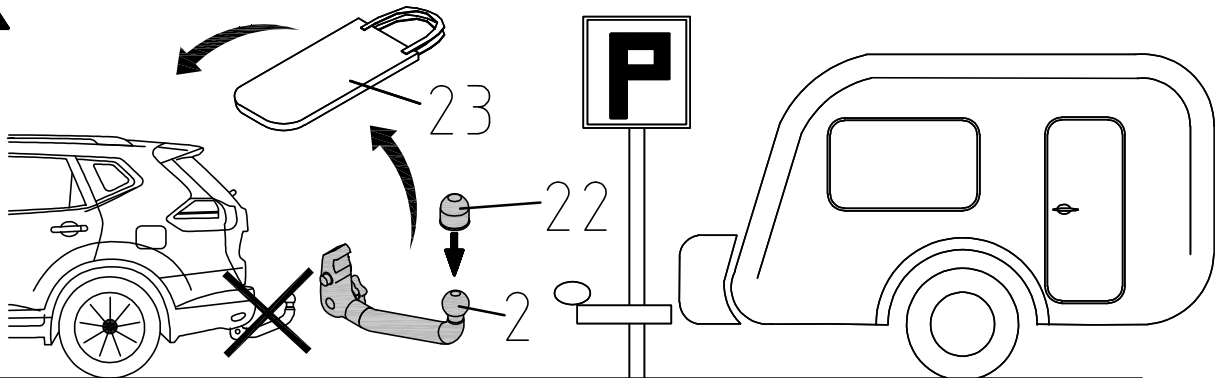
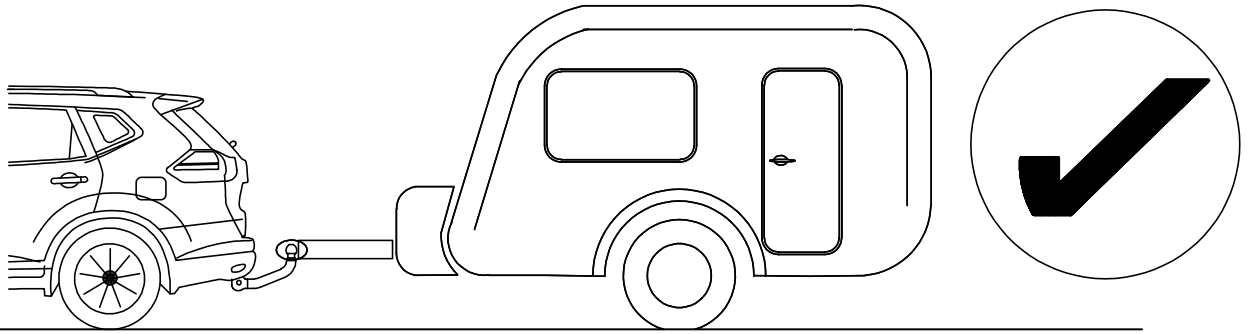

28

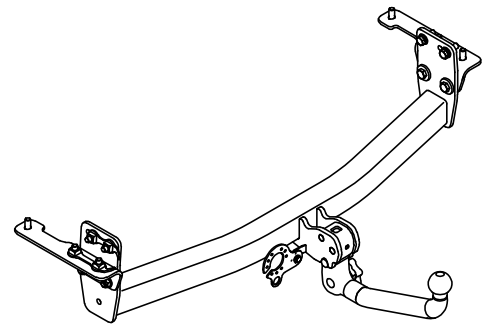
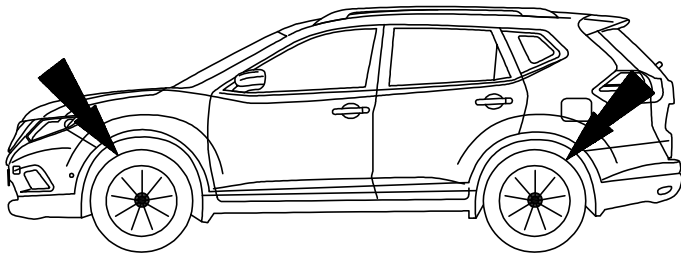

Best. Nr.: 2723 C

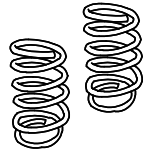
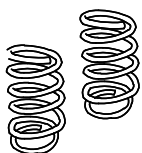
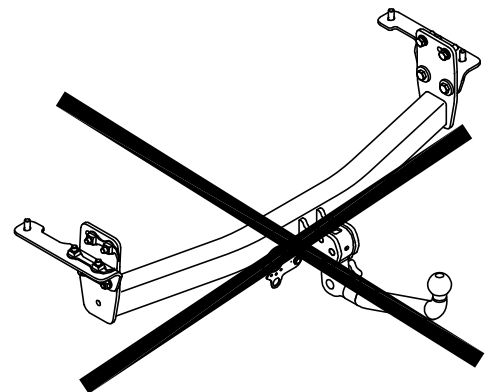
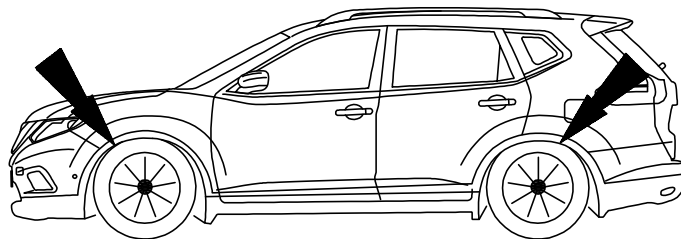
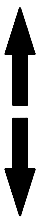

29

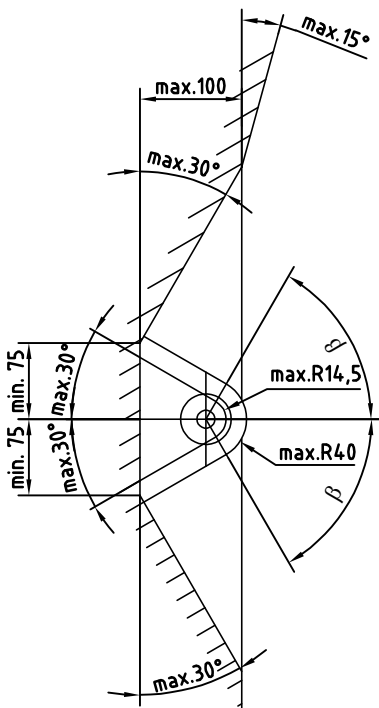
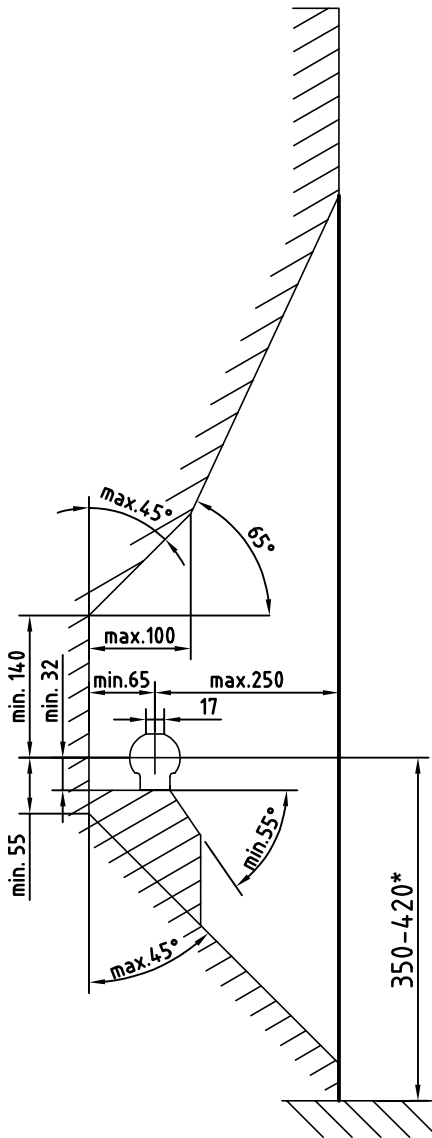

- D** Der Freiraum nach Anhang 7, Abbildung 25a und 25b der Richtlinie ECE-R 55 ist zu gewährleisten.
- CZ** Volný prostor ve smyslu Přílohy 7, obr. 25a a 25b směrnice ECE-R 55 musí být zaručen.
- DK** Det skal sikres, at der er spillerum i overensstemmelse med bilag 7, fig. 25a og 25b i henhold til direktiv ECE-R 55.
- E** Hay que garantizar el espacio libre conforme al anexo 7, fig. 25a y 25b de la directiva ECE-R 55.
- F** La zone de dégagement, selon l'annexe 7, figure 25a et 25b de la directive ECE-R 55, doit être assurée.
- FIN** Välyksen tulee täyttää ohjeen ECE-R 55 liitteen 7 kuvissa 25a ja 25b ilmoitetut vaatimukset.
- GB** Make sure to provide clearance according to appendix 7, figures 25a and 25b of the ECE-R 55 regulations.
- GR** Πρέπει να εξασφαλιστεί ο ελεύθερος χώρος σύμφωνα με το παράρτημα 7, σχήμα 25a και 25b της κοινοτικής οδηγίας ECE-R 55.
- H** Biztosítani kell az ECE-R 55 irányelv szerinti, 7. számú függelék, 25a. és 25b ábrákban jelölt szabad teret.
- I** Deve essere garantito lo spazio libero secondo l'allegato 7, figure 25a e 25b della normativa europea ECE-R 55.
- N** Det må sørges for fritt rom i samsvar med tillegg 7, figur 25a og 25b i direktiv ECE-R 55.
- NL** De vrije ruimte volgens supplement 7, afbeelding 25a en 25b van richtlijn ECE-R 55 moet gewaarborgd zijn.
- PL** Należy zapewnić wolną przestrzeń zgodnie z załącznikiem 7, rys. 25a i 25b, dyrektywy ECE-R 55.
- RUS** Оставлять свободное пространство согласно Приложению 7, рис. 25a и 25b Директивы ECE-R 55.
- S** Spelrummet enligt bilaga 7, bild 25a och 25b i riktlinje ECE-R 55, måste garanteras.

- D** \* bei zulässigem Gesamtgewicht des Fahrzeuges
- CZ** \* při celkové přípustné hmotnosti vozidla
- DK** \* ved tilladt totalvægt for køretøjet
- E** \* con peso total autorizado del vehículo
- F** \* pour poids total en charge autorisé du véhicule
- FIN** \* Ajoneuvon suurimmalla sallitulla kokonaispainolla
- GB** \* at gross vehicle weight rating
- GR** \* για το επιτρεπτό μικτό βάρος του οχήματος
- H** \* A jármű megengedett összsúlya esetén
- I** \* per il peso complessivo ammesso del veicolo
- N** \* ved kjøretøyets tillatte totalvekt
- NL** \* bij toegestaan totaal gewicht van het voertuig
- PL** \* przy dopuszczalnym ciężarze całkowitym pojazdu
- RUS** \* при допустимом общем весе автомобиля
- S** \* vid fordonets tillåtna totalvikt

- D** Die Anhängervorrichtung ist ein Sicherheitsteil und darf nur von Fachunternehmen montiert werden. Bei falscher Montage besteht schwere Unfallgefahr! Der deutsche Text dieser Anleitung ist bindend.
- CZ** Tažné zařízení je bezpečnostní součást, kterou smí montovat pouze odborné podniky. Při chybné montáži hrozí vážné nebezpečí nehody! Německý text tohoto návodu je závazný.
- DK** Anhængertrækket er en sikkerhedsdel og må kun monteres af autoriserede firmaer. Ved forkert montering er der fare for alvorlige uheld! Den tyske tekst i denne vejledning er bindende.
- E** La bola de enganche es un elemento de seguridad y sólo se debe permitir su montaje a personal cualificado. ¡En caso de montaje erróneo existe peligro de accidentes graves! Es vinculante el texto alemán de estas instrucciones.
- F** Le dispositif d'attelage est un équipement de sécurité et doit être mis en place exclusivement par un atelier spécialisé. Un montage incorrect représente un risque élevé d'accident! Le texte allemand de cette notice fait foi.
- FIN** Vetolaite on turvallisuteen vaikuttava osa, jonka saa asentaa vain alan erikoisliike. Virheellinen asennus voi aiheuttaa vakavan onnettomuuden! Tämän ohjeen saksankielinen teksti on sitova.
- GB** A trailer hitch is a safety-critical part and may be fitted only by qualified companies. Improper assembly may result in a serious accident hazard! The German text of this instruction is binding.
- GR** Ο κοτσαδόρος είναι ένα εξάρτημα ασφαλείας και η τοποθέτηση του επιτρέπεται να γίνεται μόνο από εξειδικευμένο συνεργείο. Σε περίπτωση λάθους τοποθέτησης υπάρχει κίνδυνος σοβαρών ατυχημάτων! Το γερμανικό κείμενο αυτών των οδηγιών είναι δεσμευτικό.
- H** A vonószerkezet egy biztonsági felszerelés, amelyet csak szaküzem szerelhet fel. Helytelen szerelés súlyos balesethez vezethet! A német szerelési utasítás betartása kötelező.
- I** Il gancio di traino è un componente di sicurezza e deve essere montato esclusivamente da personale specializzato. In caso di montaggio errato sussiste il pericolo di incidenti gravi! È vincolante il testo tedesco di queste istruzioni.
- N** Tilhengerfestet er en sikkerhetskomponent og skal monteres av fagbedrift. Det er stor fare for at det kan oppstå ulykker ved feil montering! Den tyske teksten i denne veiledningen er bindende.
- NL** De aanhanger is veiligheidsonderdeel en mag alleen door vakkundig personeel worden gemonteerd. Bij verkeerde montage bestaat ernstig gevaar voor ongevallen! De Duitse tekst van deze handleiding is bindend.
- PL** Hak holowniczy stanowi element bezpieczeństwa i może zostać zamontowany wyłącznie przez firmę specjalistyczną. W przypadku nieprawidłowego montażu istnieje poważne ryzyko wypadku! Tekst niniejszej instrukcji w języku niemieckim jest wiążący.
- RUS** Сцепное устройство - это узел, несущий предохранительные функции, и к его монтажу допускаются только специалисты. При неправильном монтаже грозит опасность тяжелых травм! Обязательным является немецкий текст данной инструкции.
- S** Dragkroken är en säkerhetskomponent och bör endast monteras av kvalificerade tekniker. Vid felaktig montering föreligger risk för allvarliga olyckor! Den tyska texten i denna anvisning är bindande.